

Grandstream Networks, Inc.

GXV3370

IP Multimedia Phone for Android™

User Guide



COPYRIGHT

©2021 Grandstream Networks, Inc. <http://www.grandstream.com>

All rights reserved. Information in this document is subject to change without notice. Reproduction or transmittal of the entire or any part, in any form or by any means, electronic or print, for any purpose without the express written permission of Grandstream Networks, Inc. is not permitted.

The latest electronic version of this guide is available for download here:

<http://www.grandstream.com/support>

Grandstream is a registered trademark and Grandstream logo is trademark of Grandstream Networks, Inc. in the United States, Europe, and other countries.

CAUTION

Changes or modifications to this product not expressly approved by Grandstream, or operation of this product in any way other than as detailed by this guide, could void your manufacturer warranty.

WARNING

Please do not use a different power adaptor with devices as it may cause damage to the products and void the manufacturer warranty.



FCC Statement

This equipment has been tested and found to comply with the limits for a Class B digital device, pursuant to part 15 of the FCC Rules. These limits are designed to provide reasonable protection against harmful interference in a residential installation. This equipment generates, uses, and can radiate radio frequency energy and, if not installed and used in accordance with the instructions, may cause harmful interference to radio communications. However, there is no guarantee that interference will not occur in a particular installation.

If this equipment does cause harmful interference to radio or television reception, which can be determined by turning the equipment off and on, the user is encouraged to try to correct the interference by one or more of the following measures:

- Reorient or relocate the receiving antenna.
- Increase the separation between the equipment and receiver.
- Connect the equipment into an outlet on a circuit different from that to which the receiver is connected.
- Consult the dealer or an experienced radio/TV technician for help.

The device complies with FCC radiation exposure limits set forth in an uncontrolled environment and it also complies with Part 15 of the FCC RF Rules. This equipment must be installed and operated in accordance with provided instructions and the antenna(s) used for this transmitter must be installed to provide a separation distance of at least 20 cm from all persons and must not be co-located or operating in conjunction with any other antenna or transmitter. End-users and installers must be provided with antenna installation instructions and consider removing the no-collocation statement.

This device complies with Part 15 of the FCC Rules. Operation is subject to the following two conditions: (1) this device may not cause harmful interference, and (2) this device must accept any interference received, including interference that may cause undesired operation.

Caution

Any changes or modification not expressly approved by the party responsible for compliance could void the user's authority to operate the equipment.



CE DECLARATION OF CONFORMITY

This transmitter complies with the essential requirements and provisions of directives 2014/53/EU, 2014/30/EU, 2015/35/EU, and subsequent amendments, according to standards
 ETSI EN 300 328 V2.1.1 (2016-11); EN 301 893 V2.1.1 (2017-05)
 ETSI EN 301 489-1 V2.1.1 (2017-02); ETSI EN 301 489-17 V3.1.1 (2017-02)
 EN 60950-1:2006+A11:2009+A1:2010+A12:2011+A2:2013
 EN 62311: 2008; EN62479: 2010



Manufacturer:

Grandstream Networks, Inc.
 126 Brookline Ave, 3rd Floor Boston, MA 02215, USA

EUT Feature				
Tx/Rx Frequency Range	2402~2480 MHz	2402~2480 MHz	2412~2472 MHz	5150~5250 MHz 5250~5350 MHz 5470~5725 MHz
Number of Channels	79	40 (37 hopping + 3 advertising channels)	13	UNII Band I: 802.11a/n-HT20-VHT20: 4 channels 802.11n-HT40: 2 channels UNII Band II: 802.11a/n-HT20: 4 channels 802.11n-HT40: 2 channels UNII Band III: 802.11a/n-HT20: 11 channels 802.11n-HT40: 5 channels
Carrier Frequency of Each Channel	f=2402+k MHz (k=0,1,2,...,78)	f=2402+k MHz (k=0,2,4,...,39)	-	-
Antenna Type/Gain	Internal PCB Antenna / gain 3 dBi	Internal PCB Antenna / gain 3 dBi	Internal PCB Antenna / gain 3 dBi	Internal PCB Antenna / gain 4 dBi
Type of Modulation	Bluetooth BR 1Mbps: GFSK Bluetooth EDR 2Mbps: $\pi/4$ - DQPSK Bluetooth EDR 3Mbps: 8DPSK	Bluetooth LE: GFSK	802.11b: DSSS (DBPSK / DQPSK / CCK) 802.11g/n: OFDM (BPSK / QPSK / 16QAM / 64 QAM)	802.11a/n: OFDM (BPSK / QPSK / 16QAM / 64QAM)
Operation temperature	0 °C ~ +40 °C			
Storage temperature	-10 °C ~ +60 °C			
Humidity	10 ~ 90% non-condensing			
Domestic use	Industrial use Class B			



Caution: Exposure to Radio Frequency Radiation

This equipment complies with EU radiation exposure limits set forth for an uncontrolled environment. This equipment should be installed and operated with minimum distance of 20 cm between the radiator and your body.

CE Authentication



BE	BG	CZ	DK	DE	EE	IE	EL
ES	FR	HR	IT	CY	LV	LT	LU
HU	MT	NL	AT	PL	PT	RO	SI
SK	FI	SE	NO	IS	LI	CH	TR

In all EU member states, operation of 5150-5350 MHz is restricted to indoor use only.

Hereby, Grandstream Networks, Inc. declares that the radio equipment GXV3370 is in compliance with Directive 2014/53/EU.

The full text of the EU declaration of conformity is available at the following internet address:

<http://www.grandstream.com/support/resources/>

GNU GPL INFORMATION

GXV3370 firmware contains third-party software licensed under the GNU General Public License (GPL). Grandstream uses software under the specific terms of the GPL. Please see the GNU General Public License (GPL) for the exact terms and conditions of the license.

Grandstream GNU GPL related source code can be downloaded from Grandstream web site from:

http://www.grandstream.com/sites/default/files/Resources/gxv33XX_gpl.zip



Table of Content

DOCUMENT PURPOSE	18
CHANGE LOG	19
Firmware Version 1.0.3.27	19
Firmware Version 1.0.3.25	19
Firmware Version 1.0.3.19	19
Firmware Version 1.0.3.9	19
Firmware Version 1.0.3.8	19
Firmware Version 1.0.3.3	19
Firmware Version 1.0.1.55	19
Firmware Version 1.0.1.54	19
Firmware Version 1.0.1.43	20
Firmware Version 1.0.1.33	20
Firmware Version 1.0.1.28	20
Firmware Version 1.0.1.12	20
WELCOME	21
PRODUCT OVERVIEW	22
Feature Highlights	22
GXV3370 Technical Specifications	23
GETTING STARTED	25
Equipment Packaging	25
Description of the GXV3370	26
<i>Front View</i>	26
<i>Back View</i>	27
<i>Side View</i>	28
Connecting and Setting Up the GXV3370	28
<i>Using the Phone Stand</i>	28
<i>Using the Slots for Wall Mounting</i>	29
Connecting the GXV3370	30



Cleaning the Phone	30
GETTING TO KNOW GXV3370.....	31
Use the Touchscreen	31
Use the Desktop	33
<i>Desktop Menu</i>	33
<i>Add Widget to Desktop</i>	34
<i>Manage Desktop Items</i>	34
<i>Set Wallpapers</i>	37
<i>Set Weather Widget</i>	38
<i>Manage Running Applications</i>	39
Idle Screen	40
<i>Switch Idle Screens</i>	40
<i>Set Up Idle Screen</i>	41
Use the Status Bar	42
Notifications in Status Bar	45
<i>System Settings in Status Bar</i>	47
Use the GXV3370 Keys	48
<i>Keypad Shortcut Functions</i>	48
Use the On-Screen Keyboard	49
Use the Message Waiting Indicator	51
MAKE PHONE CALLS	52
Register SIP Accounts	52
<i>Account Status</i>	52
<i>Configure SIP Account</i>	53
Dial a Number Directly	54
Redial	55
Dial a Number via Contact	55
Dial a Number via Call History	55
Direct IP Call	57
Answer a Call	57
<i>Single Incoming Call</i>	57
Preview Function for Incoming Call	59



Transfer Function for Incoming Call	59
<i>Multiple Calls/Call Waiting</i>	60
<i>Call Progress Status</i>	61
Call Hold	62
Call Recording	62
MPK Monitoring	63
Mute	64
Turn on Video during Audio Call	64
Switch Audio Channel During Call	65
Call Transfer	66
<i>Blind Transfer</i>	66
<i>Attended Transfer</i>	67
<i>Transfer via MPKs</i>	70
7-Way Conference	71
<i>Initiate Conference</i>	71
<i>Remove Party from Conference</i>	74
<i>End Conference</i>	74
<i>Hold and Resume Conference</i>	75
<i>Auto Conference Mode</i>	75
Multicast Paging	75
<i>Multicast Listening Switch</i>	75
UCM Conference	76
<i>Participate in UCM Conference Room</i>	76
<i>CCM (Conference Call Menu)</i>	77
<i>Conference Call Operations</i>	78
<i>CEI (Conference Event Indicator)</i>	79
Missed Call	81
DND (Do Not Disturb)	81
Voicemail/Message Waiting Indication	82
Call Forward	83
Call Features	85
CONTACT	87
Local Contacts	87
Add Single Contacts	87



Import/Export Contacts	88
Download Contacts.....	90
Search Contacts	90
Use Contacts.....	91
<i>Make a Call to Contacts</i>	91
<i>Select Contacts</i>	91
<i>Add Contacts to Favorites</i>	92
<i>Edit Contacts</i>	93
<i>Send Contacts to Desktop Shortcut</i>	93
<i>Share Contacts Via Bluetooth</i>	93
<i>Add Contacts to Blacklist</i>	93
<i>Add Group</i>	94
<i>Add contacts to Group</i>	94
<i>Contacts Storage Status</i>	94
GXV3370 SETTINGS.....	96
HARASSMENT INTERCEPTION	98
Blocked Contacts.....	98
Block History	98
<i>Delete Block History</i>	98
<i>Edit Blacklist</i>	99
Intercept Anonymous calls	100
CALL HISTORY.....	101
Local Call History.....	101
<i>Dial Out from Call History</i>	102
<i>Call History Options</i>	102
<i>Delete Call History</i>	102
<i>Call History Details</i>	103
SMS	104
View SMS.....	104
Create New SMS.....	105
Delete SMS	105
SMS Settings.....	106



RECORDER.....	107
Call Records.....	107
Audio Records.....	107
Recorder Settings.....	109
Files operations	111
Diagnostics	112
General Status	112
Audio Diagnostics.....	113
BACKUP AND RESTORE	116
Backup Data.....	116
Restore Backup Data.....	117
FILE MANAGER	118
Files Operations	118
<i>Copy and Paste Files.....</i>	<i>118</i>
<i>Move Files.....</i>	<i>119</i>
<i>Send Files</i>	<i>120</i>
<i>Delete Files</i>	<i>120</i>
<i>Rename a File</i>	<i>121</i>
File Categories	122
GS MARKET.....	123
FTP SERVER.....	124
CAMERA	126
Take Picture.....	126
Record Video.....	126
Angle Adjustment.....	127
Gallery.....	127
Screensaver	130
ZOOM MODE.....	132
BROWSER	133



ACTION URL	135
CONNECTING GXV3370 TO DOOR SYSTEMS	136
CONNECT TO NETWORK AND DEVICES	137
Ethernet.....	137
WI-FI	137
<i>Turn On/Off Wi-Fi.....</i>	<i>137</i>
<i>Connect to Wi-Fi Networks</i>	<i>137</i>
<i>Wi-Fi Settings Shortcut</i>	<i>139</i>
Bluetooth.....	140
<i>Turn On/Off Bluetooth.....</i>	<i>140</i>
<i>Change Bluetooth Device Name</i>	<i>141</i>
<i>Pair GXV3370 with a Bluetooth Device</i>	<i>141</i>
<i>Unpair a Bluetooth Device</i>	<i>142</i>
<i>Bluetooth Settings Shortcut.....</i>	<i>142</i>
EHS Headset.....	143
USB Headset.....	144
USB	146
SD Card	146
EMERGENCY CALL.....	147
GXV3370 GUI CUSTOMIZATION TOOL.....	148
EXPERIENCING THE GXV3370 APPLICATION PHONE	149



Table of Tables

Table 1: GXV3370 Features in a Glance	22
Table 2: GXV3370 Technical Specifications.....	23
Table 3: Equipment Packaging.....	25
Table 4: GXV3370 Front View.....	26
Table 5: GXV3370 Back View	27
Table 6: GXV3370 Side View	28
Table 7: GXV3370 Status Bar Notification Icons.....	45
Table 8: GXV3370 Keys.....	48
Table 9: GXV3370 MWI LED Status.....	51
Table 10: GXV3370 Feature Code	85



Table of Figures

Figure 1: GXV3370 Package Content	25
Figure 2: GXV3370 Front.....	26
Figure 3: GXV3370 Back View.....	27
Figure 4: GXV3370 Side View	28
Figure 5: Built in Stand and Mounting Slots on GXV3370.....	29
Figure 6: Tab on The Handset Cradle.....	29
Figure 7: GXV3370 Back / Side View.....	30
Figure 8: GXV3370 Default Home Screen.....	31
Figure 9: GXV3370 Onscreen Menu	31
Figure 10: GXV3370 Finger Gestures on the Touch Screen	32
Figure 11: GXV3370 Desktop Menu.....	33
Figure 12: Add Widget to the Desktop.....	34
Figure 13: Open Clock Widget.....	35
Figure 14: Resize MPK Widget.....	35
Figure 15: Move Clock Widget.....	36
Figure 16: Creating a Folder grouping Apps.....	36
Figure 17: Renaming the Folder.....	37
Figure 18: GXV3370 Choose Wallpaper	38
Figure 19 : Accessing available Widgets	38
Figure 20 : Minimized display of Weather App.....	39
Figure 21: Maximized Display of Weather APP	39
Figure 22: GXV3370 Recent Applications	40
Figure 23: GXV3370 Switch Idle Screens	40
Figure 24: Set up Home Idle Screen	41
Figure 25: Add an Idle Screen.....	42
Figure 26: Delete an Idle Screen.....	42
Figure 27: GXV3370 Top Status Bar	43
Figure 28: Status Bar - More Options.....	43
Figure 29: GXV3370 Top Status Bar – Notification	44
Figure 30: GXV3370 Top status Bar - Get more information	44
Figure 31: GXV3370 Top status Bar – Wi-Fi.....	45
Figure 32: System Settings in Status Bar	47
Figure 33: GXV3370 Keys	48
Figure 34: GXV3370 Onscreen Keyboard - English Keyboard.....	49
Figure 35: GXV3370 Onscreen Keyboard - Lowercase and Uppercase.....	50
Figure 36: English Keyboard - Number and Symbols	50
Figure 37: English Keyboard - More Symbols	50
Figure 38: GXV3370 Account Widget.....	52
Figure 39: GXV3370 Dial Screen	53
Figure 40: Disable Video Call Feature on Dial Screen	54



Figure 41: GXV3370 View Contacts.....	55
Figure 42: GXV3370 Call History	56
Figure 43 : Call Details	56
Figure 44: Select call Mode Audio or Video Call	57
Figure 45: Single Incoming Call – Audio.....	58
Figure 46: Single Incoming Call – Video.....	58
Figure 47: Single Incoming Call – Preview-1	59
Figure 48: Single Incoming Call – Preview-2.....	59
Figure 49: Single Incoming Call – Transfer-1.....	60
Figure 50: Single Incoming Call – Transfer-2.....	60
Figure 51: Call Waiting.....	61
Figure 52: Touch to Return to Call Screen.....	61
Figure 53: Call on Hold	62
Figure 54: GXV3370 Call Recording	62
Figure 55: MPK button.....	63
Figure 56: MPK list	63
Figure 57: GXV3370 Call Mute	64
Figure 58: Turn on Video During Audio Call.....	64
Figure 59: Accept Video During Audio Call	65
Figure 60: Switch Audio Channel during Call.....	66
Figure 61: Blind Transfer.....	67
Figure 62: Attended Transfer.....	68
Figure 63: Attended Transfer - Transferring.....	68
Figure 64: Attended Transfer – Transfer Now - Split	69
Figure 65: Attended Transfer.....	69
Figure 66: Transfer via MPK	70
Figure 67: MPK list	70
Figure 68: Add Conference Members from Dial Screen.....	71
Figure 69: Add Conference Members from Dial Screen 2.....	71
Figure 70: GXV3370 Conference Screen	72
Figure 71: GXV3370 Conference - Add Existing Call to Conference	73
Figure 72: 3-Way Conference Call Established	73
Figure 73: Notification of joining the conference	73
Figure 74: Notification of exiting the conference	74
Figure 75: GXV3370 Conference - Remove Party from Conference	74
Figure 76: Multicast Listening widget – On.....	76
Figure 77 : Join UCM Conference Room.....	76
Figure 78: UCM conference Menu	77
Figure 79 : Conference Menu Options	77
Figure 80: Conference's members list.....	78
Figure 81: Invite a member	78
Figure 82: Conference Bridge.....	79
Figure 83: Member joined conference Event.....	80



Figure 84 : Member Left the conference room Event.....	80
Figure 85: Invitation sent Event Notification.....	80
Figure 86: Missed Call Screen	81
Figure 87: Enable/Disable DND	82
Figure 88: Retrieve Voicemail	83
Figure 89: Unconditional Call Forward	83
Figure 90: Call Forward – Unconditional	84
Figure 91: Call Forward - Time Based	84
Figure 92: Call Forward - Busy/No Answer/DND	84
Figure 93: GXV3370 Contacts	87
Figure 94: GXV3370 Contacts - Add New Contact	88
Figure 95: Add to Contacts from Dial Pad	88
Figure 96: GXV3370 Contacts - Import Contacts.....	89
Figure 97: GXV3370 Contacts - Export Contacts	89
Figure 98: GXV3370 Contacts - Download Contacts	90
Figure 99: GXV3370 Contacts - Search Contacts	91
Figure 100: GXV3370 Contacts - Select Contacts.....	92
Figure 101: Add Contacts to Favorites	92
Figure 102: GXV3370 Contacts - Add New Group.....	94
Figure 103: GXV3370 Contacts - Storage Status	95
Figure 104: GXV3370 Settings	96
Figure 105: List of blocked contacts.....	98
Figure 106: Block History.....	98
Figure 107: GXV3370 Blacklist - Add Number to Blacklist	99
Figure 108: Manually Add Number to Blacklist	99
Figure 109: Intercept Anonymous Calls.....	100
Figure 110: GXV3370 Call History.....	101
Figure 111: GXV3370 Call History – Options.....	102
Figure 112: GXV3370 Call History - Details.....	103
Figure 113: GXV3370 SMS Message.....	104
Figure 114: View SMS Dialog.....	104
Figure 115: Create a New SMS.....	105
Figure 116: Recorder Application	107
Figure 117: Recording audio	108
Figure 118 : Flag Mark.....	108
Figure 119: Recorded files	108
Figure 120: Recorder Menu	109
Figure 121: Menu options	109
Figure 122: Recorder Settings	110
Figure 123: Password Set.....	110
Figure 124: Change Password.....	110
Figure 125: Files operation	111
Figure 126: Export/Send/Delete files.....	111



Figure 127: General Status.....	112
Figure 128: Start the General status Diagnostic.....	112
Figure 129: Speaker Diagnostic.....	113
Figure 130: Ongoing Speaker Diagnostic.....	113
Figure 131: Abnormal status.....	114
Figure 132: Normal Status.....	114
Figure 133: Microphone Diagnostic.....	114
Figure 134: Recording Audio sound.....	114
Figure 135: Microphone Diagnostic Done.....	115
Figure 136: Normal Status.....	115
Figure 137: Abnormal Status.....	115
Figure 138: GXV3370 Backup App Main Screen.....	116
Figure 139: GXV3370 Backup App Main Screen.....	116
Figure 140: Restore Backup Data.....	117
Figure 141: GXV3370 File Manager – Copy File.....	118
Figure 142: Paste File.....	119
Figure 143: GXV3370 File Manager - Move.....	119
Figure 144: GXV3370 File Manager - Options.....	120
Figure 145: Delete File(s) via File Manager.....	121
Figure 146: Rename File.....	121
Figure 147: GS Market - Onscreen Menu.....	123
Figure 148: FTP Server – Start.....	124
Figure 149: FTP Server – Stop.....	124
Figure 150: FTP Server – Settings.....	125
Figure 151: GXV3370 Camera.....	126
Figure 152: Recent pictures and videos page.....	127
Figure 153: Edit picture.....	128
Figure 154: Access to the Gallery.....	128
Figure 155: GXV3370 Gallery.....	129
Figure 156: GXV3370 Gallery - Picture Options.....	129
Figure 157: Screensaver settings.....	130
Figure 158: Use Network Images.....	131
Figure 159: Network Image Path.....	131
Figure 160: Zoom Mode feature enabled.....	132
Figure 161: Example of file manager app's display after enabling the zoom feature.....	132
Figure 162: GXV3370 Web Browser.....	133
Figure 163: GXV3370 Browser Menu Options.....	133
Figure 164: Open New Window in Browser.....	134
Figure 165: GXV3370 Web Browser-Bookmarks.....	134
Figure 166: Incoming call from GDS3710 door system.....	136
Figure 167: GXV3370 Connect to Wi-Fi.....	138
Figure 168: GXV3370 Connect to Wi-Fi-Show Advanced Options.....	138
Figure 169: Wi-Fi - Add network.....	139



Figure 170: Wi-Fi Settings Shortcut.....	139
Figure 171: Wi-Fi Shortcut - Wi-Fi List	140
Figure 172: GXV3370 Bluetooth - Paired Device.....	142
Figure 173: Bluetooth Settings Shortcut.....	142
Figure 174: Bluetooth Setting shortcut 2	143
Figure 175: EHS headset.....	143
Figure 176: USB Headset Connected	144
Figure 177: USB Headset Used for Call	145
Figure 178: Switch Between Speaker and USB mode.....	145
Figure 179: USB Storage Device Connected to GXV3370.....	146
Figure 180: Emergency Access under GXV3370 Locked Screen	147
Figure 181: Emergency Dial Screen.....	147



DOCUMENT PURPOSE

This document describes how to configure the GXV3370 via phone's LCD menu and web UI menu to fully manipulate phone's features. To learn advanced functions of GXV3370, please visit <http://www.grandstream.com/support> to download the latest "GXV3370 Administration Guide".

This guide covers following topics:

- [Product Overview](#)
- [Getting started](#)
- [Getting to know GXV3370](#)
- [Make phone calls](#)
- [Contacts](#)
- [GXV3370 Settings](#)
- [Harassment Interception](#)
- [Call history](#)
- [SMS](#)
- [File manager](#)
- [GS Market](#)
- [FTP Server](#)
- [Camera](#)
- [Browser](#)
- [Action URL](#)
- [Connecting GXV3370 to Door Systems](#)
- [Connect to network and devices](#)
- [Emergency call](#)
- [GXV3370 GUI Customization Tool](#)
- [Experiencing the GXV3370 applications](#)



CHANGE LOG

This section documents significant changes from previous versions of user guide for GXV3370. Only major new features or major document updates are listed here. Minor updates for corrections or editing are not documented here.

Firmware Version 1.0.3.27

- Added a “Mute” option to account ring tone list. [Account Ringtones]

Firmware Version 1.0.3.25

- Supported switching cities from the weather widget directly. [Weather Widget]
- Updated “No/Noise” button in Audio Diagnostics to two separate ones. [Audio Diagnostics]
- Supported selecting call mode when calling from history. [Call History]
- Updated calling account display to Account Name instead of SIP Authentication ID. [Account Status]
- Updated button in attended transfer from “Blind” to “Transfer now”. [Attended Transfer]
- Added call type icon in Call History app to indicate audio or video calls. [Call Type]
- Added support that Apps can be grouped into folders on home screen. [Group Apps]
- Added multicast intercom global switch in LCD widget. [Multicast]

Firmware Version 1.0.3.19

- Added support for integrated call control features with GUV3000/3005 [USB Headset]
- Display the caller information when monitored BLF is ringing.

Firmware Version 1.0.3.9

- No Major Changes.

Firmware Version 1.0.3.8

- No Major Changes.

Firmware Version 1.0.3.3

- No Major Changes.

Firmware Version 1.0.1.55

- No Major Changes.

Firmware Version 1.0.1.54

- Added support for configuring 2 Access Passwords to control the same GDS System.



[CONNECTING GXV3370 TO DOOR SYSTEMS]

- Added support for Zoom Mode feature. [ZOOM MODE]
- Added Backup and Restore application. [BACKUP AND RESTORE]
- Added support for direct or quick IP call, and paging call mode selection in Dial pad. [Dial a Number Directly] [Direct IP Call]

Firmware Version 1.0.1.43

- Added CEI and CCM support for UCM Conference. [CCM (Conference Call Menu)] [CEI (Conference Event Indicator)]
- Improved UI for LCD display such as Voicemail, MPK, Settings, File Manager, call screen.
- Added recording application on LCD. [RECORDER]
- Added support to transfer a call via MPK BLF. [Transfer via MPKs]
- Added support for large MPK widget. [Figure 14: Resize MPK Widget]
- Added support for Czech language. [GXV3370 Technical Specifications]
- Added ability to view and play recordings in Call Log app. [RECORDER]
- Added ability to monitor MPK on call screen while on active call [MPK Monitoring]

Firmware Version 1.0.1.33

- Supported changing input keyboard on LCD. [Use the On-Screen Keyboard]
- Supported RJ9 headset switch in dropdown panel. [Use the Status Bar]
- Modified the UI in LCD Settings. [GXV3370 SETTINGS]
- Added notification for full screen video conference when a member joins or exits. [Initiate Conference]
- Added “Emergency calling...” in emergency call interface. [EMERGENCY CALL]
- Changed the default page in Browser to Google Search. [BROWSER]
- Added dial tone when starting inviting conference members. [Initiate Conference]
- Added prompt when number of imported contacts reach the limit. [Local Contacts]
- Added SMS app. [SMS]
- Added FTP server in File Manager. [FTP SERVER]

Firmware Version 1.0.1.28

- Added different service type to web UI Value-added Service. [Value-added Service]
- Added the conference call date and duration on the top of screen from Call History. [Call History Details]
- Supported adjusting the MPK widget height. [MPK Widget]

Firmware Version 1.0.1.12

- This is the initial version.



WELCOME

Thank you for purchasing Grandstream GXV3370 IP Multimedia Phone for Android™. The GXV3370 IP Video Phone for Android combines a 16-line IP video phone with a multi-platform video conferencing solution and the functionality of an Android tablet to offer an all-in-one communications solution. The phone features a 7" 1024x600 capacitive touch screen TFT LCD, Mega pixel camera, dual Gigabit ports with PoE/PoE+, HD audio and video, integrated Wi-Fi (802.11a/b/g/n) & Bluetooth, rich peripheral interfaces, and Android 7.0. By combining a state-of-the-art IP video phone, an advanced video conferencing solution, and the functionality of a tablet, businesses throughout the world can now use the GXV3370 for all communication and productivity needs.



PRODUCT OVERVIEW

Feature Highlights

The following tables contain the major features of the GXV3370:

Table 1: GXV3370 Features in a Glance

 <p>GXV3370</p>	<ul style="list-style-type: none"> • 16 lines with up to 16 SIP accounts, up to 7-way audio conference and 3-way 720p 30fps HD video conference, phonebook with up to 1000 contacts, call history with up to 1000 records. • Dual switched 10/100/1000Mbps network ports, Dual-band 2.4GHz & 5GHz Wi-Fi (802.11a/b/g/n), PoE/PoE+, Bluetooth 4.0+EDR, USB, SD, HDMI, EHS with Plantronics headsets support. • 7" (1024x600) capacitive (5 points) touch screen TFT LCD, mega pixel CMOS sensor camera with privacy shutter. • HD wideband audio, full-duplex hands-free speakerphone with HD acoustic chamber, advanced acoustic echo cancellation and excellent double-talk performance. • Runs the Android™ Operating System 7.0. • Built-in support for GXV series of video surveillance cameras, and GDS37xx series of access control devices. • Create Android applications for any business need to run on GXV3370 using Google's API and Grandstream's SDK toolkit.
--	---

GXV3370 Technical Specifications

The following table resumes all the technical specifications including the protocols / standards supported, voice codecs, telephony features, languages, and upgrade/provisioning settings for the phone GXV3370.

Table 2: GXV3370 Technical Specifications

Protocols/Standards	SIP RFC3261, TCP/IP/UDP, RTP/RTCP, HTTP/HTTPS, ARP, ICMP, DNS (A record, SRV, NAPTR), DHCP, PPPoE, SSH, TFTP, NTP, STUN, SIMPLE, LLDP-MED, LDAP, TR-069, 802.1x, TLS, SRTP, IPv6, OpenVPN®.
Network Interfaces	Dual switched 10/ 100/ 1000 Mbps ports with integrated PoE/PoE+
Graphic Display	7" 1024x600 capacitive touch screen (5 points) TFT LCD
Camera	Tiltable mega-pixel CMOS camera with privacy shutter, 720P@30fps
Bluetooth	Yes, integrated. Bluetooth 4.0+EDR.
Wi-Fi	Yes, dual-band 2.4 & 5GHz with 802.11 a/b/g/n
Auxiliary Ports	RJ9 headset jack (allowing EHS with Plantronics headsets), 3.5mm stereo headset with microphone, USB port, SD, HDMI-out (1.4 up to 720p30fps)
Feature Keys	2 function touch keys VOLUME +/-, 3 dedicated Android touch keys HOME, MENU, and BACK
Voice Codec	G.711μ/a, G.722 (wide-band), G.726-32, iLBC, Opus, G.729A/B in-band and out-of-band DTMF (In audio, RFC2833, SIP INFO), VAD, CNG, AEC, PLC, AJB, AGC, ANS
Video Codec and Capabilities	H263, H.264 BP/MP/HP, video resolution up to 720p, frame rate up to 30 fps, bit rate up to 2Mbps, 3-way video conference (720p@30fps), anti-flickering, auto focus and auto exposure
Telephony Features	Hold, transfer, forward (unconditional/no-answer/busy), call park/pickup, 7-way audio conference(including the host), shared-call-appearance (SCA) / bridged-line-appearance (BLA), virtual MPK, downloadable contacts (XML, LDAP, up to 1000 items), call record, call log (up to 1000 records), call waiting, auto answer, XML customization of screen, click-to-dial, flexible dial plan, hot desking, personalized music ringtones and music on hold, server redundancy & fail-over
Sample Applications	Local apps: Contacts, Call History, File Manager, MPK, Settings, Browser, Voicemail, Clock, Recorder, SMS, Backup and restore ,etc. Support 3rd party apps: Skype, Google Hangouts, Skype for Business, etc. API/SDK available for advanced custom application development.
Applications Deployment	Allow Android 7.0 compliant applications to be developed, downloaded, and run in the embedded device with provisioning control



HD Audio	Yes, HD handset and speakerphone with support for wideband audio
Base Stand	Yes, integrated stand with multiple adjustable angles. Wall mountable
QoS	Layer 2 QoS (802.1Q, 802.1p) and Layer 3 (ToS, DiffServ, MPLS) QoS
Security	User and administrator level passwords, MD5 and MD5-sess based authentication, 256-bit AES encrypted configuration file, TLS, SRTP, HTTPS, 802.1x media access control
Multi-language	English, German, Italian, French, Spanish, Portuguese, Russian, Croatian, Chinese, Korean, Japanese, Czech, and more
Upgrade/ Provisioning	Firmware upgrade via TFTP / HTTP / HTTPS or local HTTP upload, mass provisioning using TR-069 or AES encrypted XML configuration file
Power and Green Energy Efficiency	<p>Universal power adapter included: Input: 100-240VAC 50-60Hz; Output 12VDC 1.5A</p> <p>Integrated PoE* 802.3af Class 3, PoE+ 802.3at, Class 4</p> <p><i>*When using PoE to power up phone, the USB port will not work.</i></p>
Physical	<p>Dimension : 252mm (W) x 211mm (L) x 84mm (H)</p> <p>Unit weight: 1.08kg</p> <p>Package weight: 1.77kg</p>
Temperature and Humidity	<p>Operation: 0°C to 40°C</p> <p>Storage: -10°C to 60°C</p> <p>Humidity: 10% to 90% Non-condensing</p>
Package Content	GXV3370 phone, handset with cord, base stand, universal power supply, network cable, screen cleaning cloth, quick installation guide, brochure, GPL license
Compliance	<p>FCC: Part 15 (CFR 47) Class B; UL 60950 (power adapter); Part68 (HAC)</p> <p>CE: EN55022 Class B, EN55024, EN61000-3-2, EN61000-3-3, EN60950-1, EN62479, RoHS</p> <p>RCM: AS/ACIF S004; AS/NZS CISPR22/24; AS/NZS 60950; AS/NZS 4268</p> <p>IC: ICES 003, RSS 247, CS 03, RSS 102</p>

GETTING STARTED

This chapter provides basic installation instructions including the list of the packaging contents and also information for obtaining the best performance with the GXV3370.

Equipment Packaging

Table 3: Equipment Packaging

GXV3370
<ul style="list-style-type: none"> • 1x GXV3370 Main Case. • 1x Handset. • 1x Phone Cord. • 1x Ethernet Cable. • 1x 12V Power Adapter. • 1x Wall Mount. • 1x Screen Cleaning Cloth. • 1x Quick Installation Guide. • 1x GPL License.

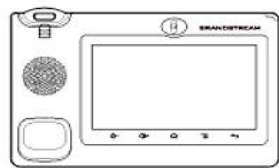

1 X GXV3370 Main Case



1 X Handset



1 X Phone Cord



1 X Ethernet Cable



1 X 12V Power Adapter

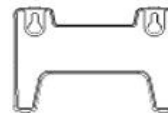

1 X Wall Mount

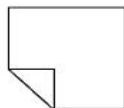

1 X Screen Cleaning Cloth



1 X Quick Installation Guide / 1 X GPL Licence

Figure 1: GXV3370 Package Content

Note: Check the package before installation. If you find anything missing, contact your system administrator.

Description of the GXV3370

Front View

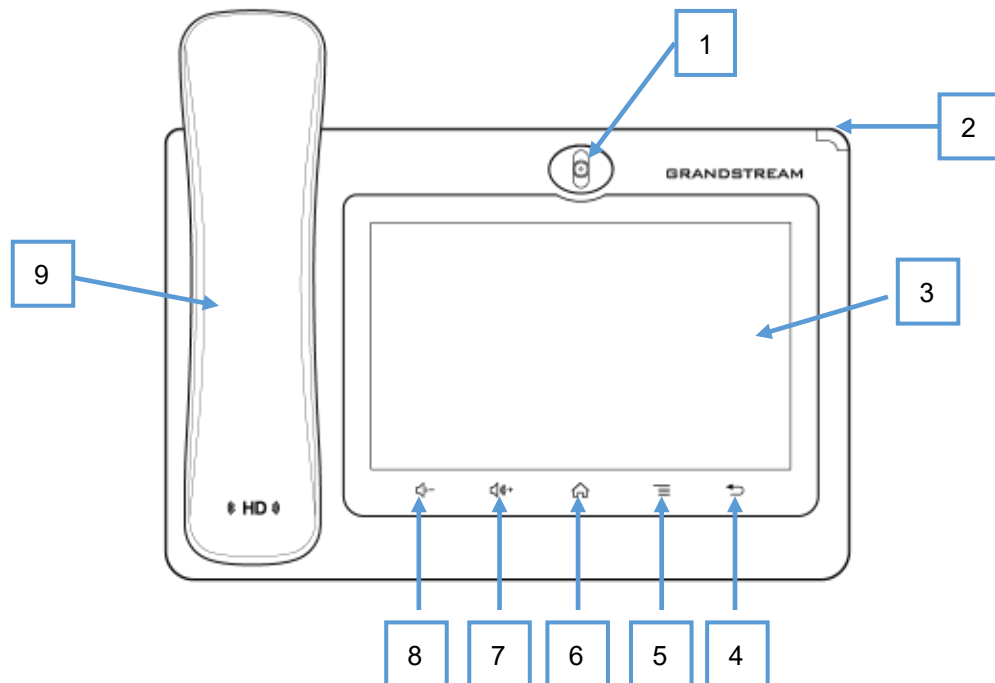

Figure 2: GXV3370 Front

Table 4: GXV3370 Front View

Item	Name	Description
1	Front Camera	Mega pixel front camera. The angle can be adjusted, and the camera can be blocked by scrolling up/down the wheel on the back of the camera.
2	MWI LED Indicator	To indicate message status, call status and phone's system status using the LED indicator.
3	LCD	7" (1024x600) capacitive (5 points) touch screen.
4	Back	Tap to go back to the previous menu.
5	Menu	Press MENU key to access phone's display settings, edit widgets and thread manager. Or press and hold on the MENU key for 2 seconds to enter managing application interface directly.
6	Home	Tap to go back to Home screen; or touch and press for about 2 seconds to take a screenshot of phone's screen.
7	Volume Up	Tap to turn up the call volume and media volume.
8	Volume Down	Tap to turn down the call volume and media volume.
9	Handset	Off hook to use handset as the audio channel for calls and media.

Back View

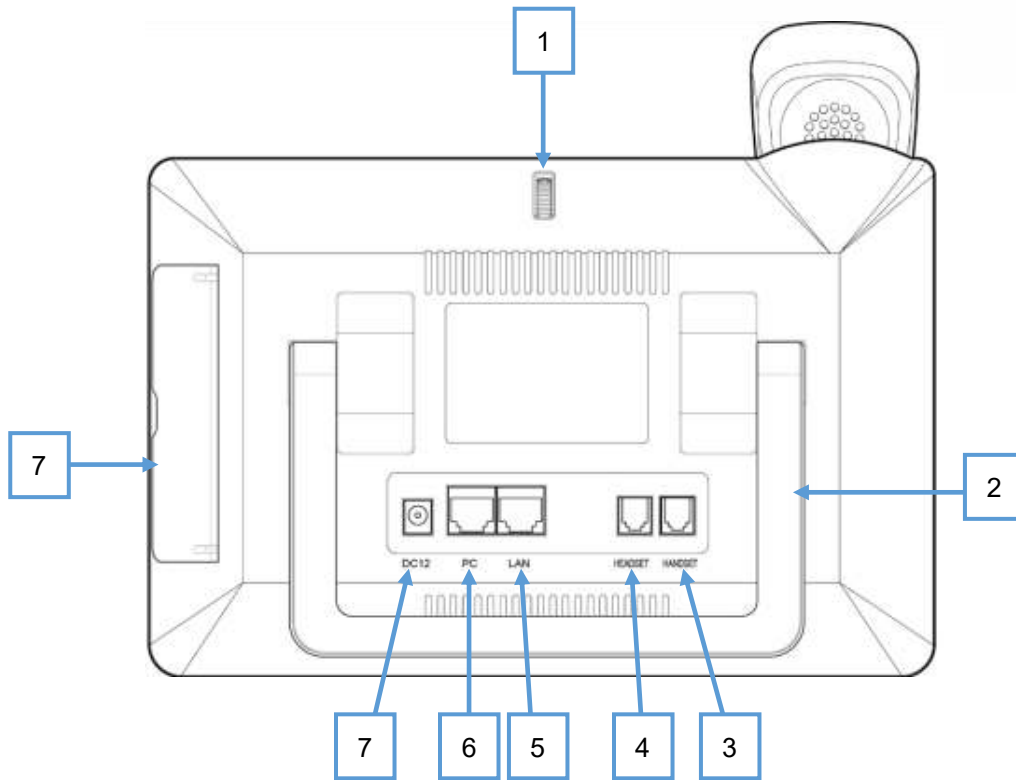

Figure 3: GXV3370 Back View

Table 5: GXV3370 Back View

Item	Name	Description
1	Camera Adjusting Wheel	Scroll up/down to adjust the camera angle.
2	Phone Stand (built-in)	Adjust the phone stand angle to place the phone on the desk.
3	Handset Port	RJ9 handset connector port.
4	Headset Port	RJ9 headset connector port (supporting EHS with Plantronics headset).
5	LAN Port	10/100/1000Mbps RJ-45 port connecting to Ethernet. PoE/PoE+ is supported.
6	PC Port	10/100/1000Mbps RJ-45 port connecting to PC.
7	Power Jack	12V DC Power connector port.
8	Side Connectors Cover	Open the cover for USB port, SD card slot, 3.5mm headset port and mini HDMI port.

Side View

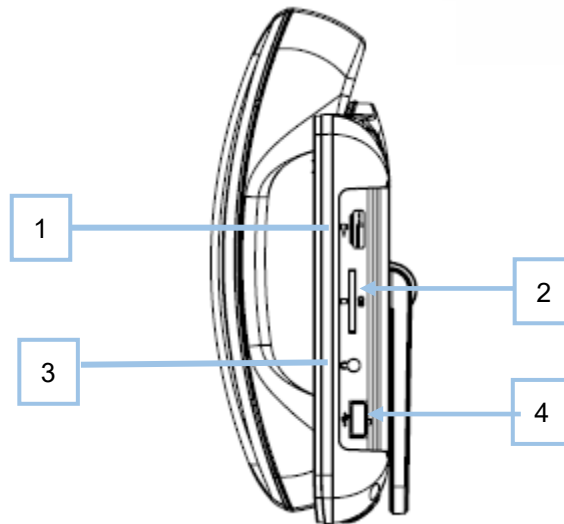

Figure 4: GXV3370 Side View

Table 6: GXV3370 Side View

Item	Name	Description
1	HDMI Port	Connect display device to the HDMI port via HDMI cable.
2	SD Card Port	Connect SD storage device to the SD Card Slot.
3	3.5mm Headset Port	Connect 3.5mm headset.
4	USB Port	USB devices can be connected via the USB port. For example, connect a USB flash drive to save captured pictures.

Connecting and Setting Up the GXV3370

The GXV3370 can be installed on the desktop using the built-in stand or attached on the wall using the slots for wall mounting.

Using the Phone Stand

The GXV3370 has a built-in phone stand. To set up the GXV3370 as your desk phone, follow the steps below:

1. Take the phone stand out on the back and adjust the angle to place the phone steady on the desk;
2. Connect the handset and main phone case with the phone cord;
3. Connect the LAN port of the phone to the RJ-45 socket of a hub/switch or a router (LAN side of the router) using the Ethernet cable;
4. Connect the 12V DC output plug to the power jack on the phone; plug the power adapter into an electrical outlet. If PoE switch is used in step 3, this step could be skipped;



The LCD will display the booting up screen or firmware upgrading information. Before continuing, please wait for the main screen display to show up.

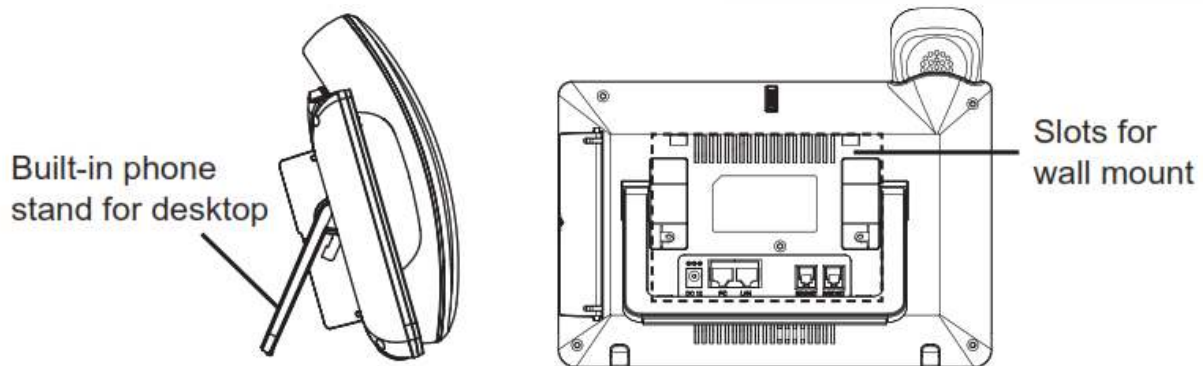

Figure 5: Built in Stand and Mounting Slots on GXV3370

Using the Slots for Wall Mounting

1. Attach the wall mount to the slots on the back of the phone;
2. Attach the phone to the wall via the wall mount hole;
3. Pull out the tab from the handset cradle (see figure below);
4. Rotate the tab and plug it back into the slot with the extension up to hold the handset while the phone is mounted on the wall.
5. Connect the handset and main phone case with the phone cord;
6. Connect the LAN port of the phone to the RJ-45 socket of a hub/switch or a router (LAN side of the router) using the Ethernet cable;
7. Connect the 12V DC output plug to the power jack on the phone; plug the power adapter into an electrical outlet. If PoE switch is used in step 3, this step could be skipped;

The LCD will display the booting up screen or firmware upgrading information. Before continuing, please wait for the main screen display to show up.

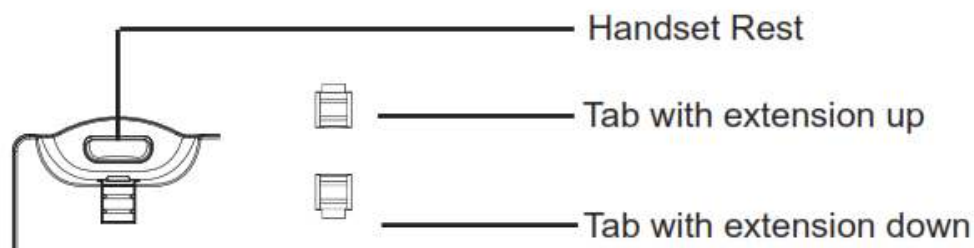

Figure 6: Tab on The Handset Cradle

Connecting the GXV3370

To setup your GXV3370, please follow the steps below:

1. Connect the handset and main phone case with the phone cord;
2. Connect the LAN port of the phone to the RJ-45 socket of a hub/switch or a router (LAN side of the router) using the Ethernet cable;
3. Connect the 12V DC output plug to the power jack on the phone; plug the power adapter into an electrical outlet. If PoE switch is used in step 2, this step could be skipped;
4. The LCD will display booting up or firmware upgrading information. Before continuing, please wait for the main screen display to show up;
5. Using the web configuration interface or from the menu of the touch screen, you can further configure network connection using static IP, DHCP etc.

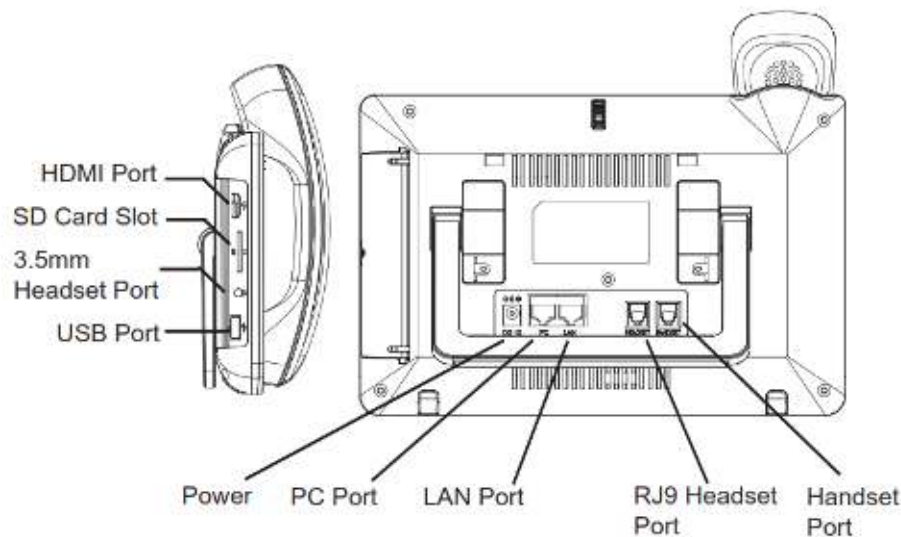

Figure 7: GXV3370 Back / Side View

Cleaning the Phone

For daily dust removal and fingerprint removal, please use the screen cleaning cloth in the factory package to wipe the phone. For some special cases like medical environment, you can use medical alcohol or isopropanol. The steps are as followed:

1. Before cleaning the phone, stop using it and disconnect it from the power supply.
2. Spray a small amount of disinfectant on screen, camera, handle, and other places that are easily touched by users.
3. Wipe the phone with screen cleaning cloth.
4. Power on until the disinfectant is completely volatilized.

Notes:

- Keep the power plug clean and dry or may lead to electric shock or other perils.
- DO NOT use disinfectant too frequently.
- DO NOT use high degree or even pure disinfectant. It could damage the phone.



GETTING TO KNOW GXV3370

Use the Touchscreen

When the phone boots up in HOME screen, the LCD will display as below. A registered account is shown in the following figure and users might need register their own account to have the account status displayed.

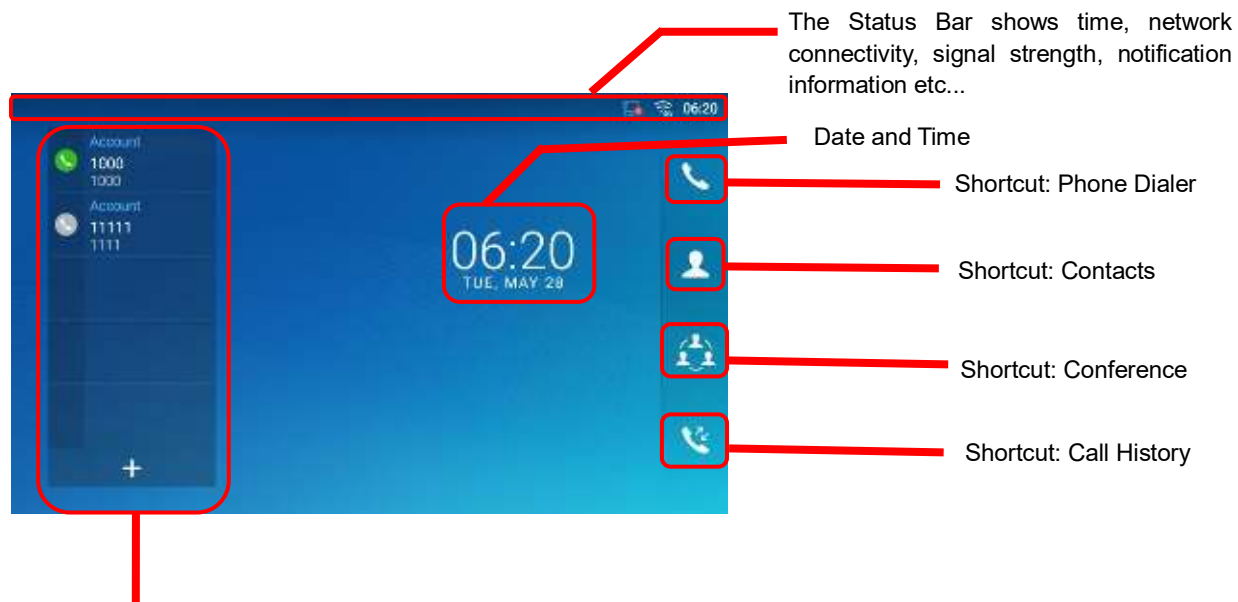

Account information Widget. Up to 8 accounts/Programmable keys can be displayed.

Figure 8: GXV3370 Default Home Screen

Swipe from right to left to show the application menu of the phone. the settings and applications installed will be brought up as shown below.



Figure 9: GXV3370 Onscreen Menu



To fully manipulate the GXV3370 capacitive touch screen, use your fingers to operate the following on the GXV3370 icons, buttons, menu items, onscreen keyboard etc.

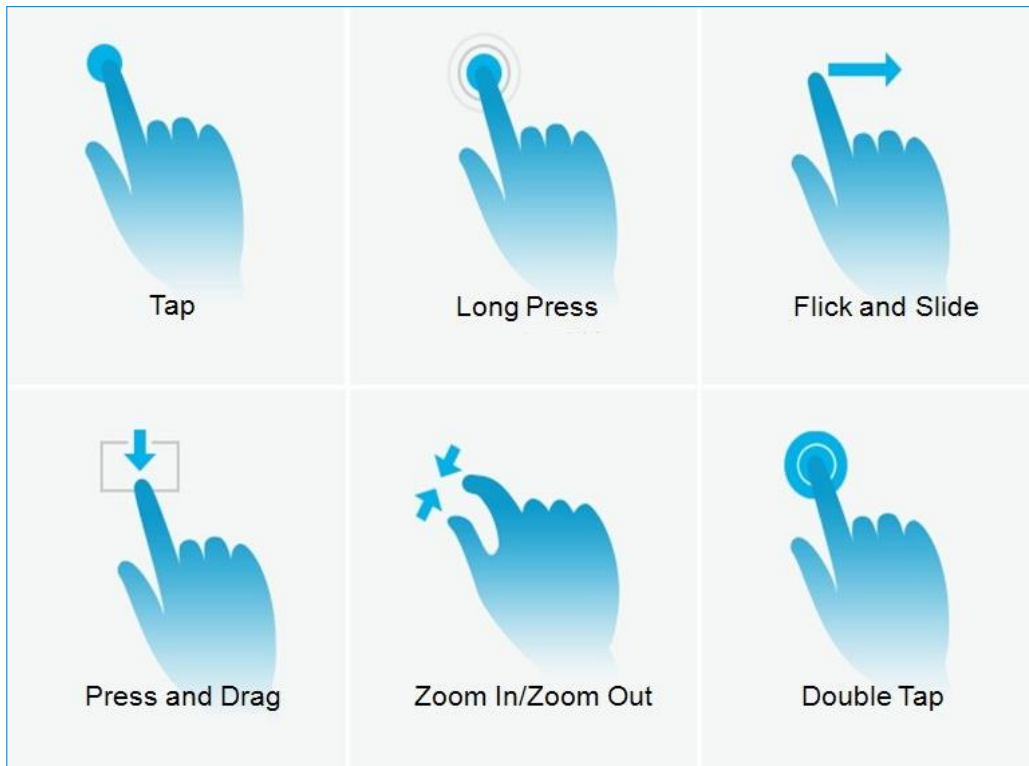

Figure 10: GXV3370 Finger Gestures on the Touch Screen

- Tap**
 Slightly touch the screen with fingertip to initiate menu, options, or applications. For example, to select items on the screen (e.g., setting options, apps etc.); to press onscreen buttons (e.g., "End" or "Options" softkey during the call); to type letters and symbols using the onscreen keyboard.
- Long Press**
 Touch the screen with fingertip and press for about 2 seconds without lifting your finger from the screen till an action occurs. For example, long press on a picture to bring up selection option.
- Flick and Slide**
 Touch the screen with fingertip and slide over the screen. For example, user could slide up to scroll up the page, slide down to open dropdown menu, slide left or slide right to delete an item from the list. If your finger stays on the screen for too long, the item may be selected, and sliding will not occur.
- Press and Drag**
 Touch and press the item, then move it by dragging it up, down, left, or right, without lifting your finger from the screen.

- **Zoom In/Zoom Out**
Place two fingers on the screen, then pinch them together (zoom out) or spread them apart (zoom in).
- **Double Tap**
Quickly touch the screen twice with fingertip to switch between default display and zoomed-in display. This is usually used when viewing photos or web pages.

Use the Desktop

Desktop Menu

When the GXV3370 is on idle screen, press the MENU key  to bring up phone's menu. Users can access the following in the desktop menu:



Figure 11: GXV3370 Desktop Menu

- **Desktop page**
Add, delete, or edit desktop pages, set Home page, and change the screen sequence.
- **Wallpaper**
Select wallpaper from Local gallery or from the available system Wallpapers
- **Widgets**
Add widgets to the desktop by touching and holding the widget from the widget menu.
- **Management**
Manage running applications on the GXV3370. For more details, please refer to section [Set Weather Widget].

Add Widget to Desktop

The GXV3370 provides widgets like account bar, clock, contacts etc. Users could conveniently add those widgets to the desktop as preferred. To add a widget:

1. Press the Menu key  or long press on an empty space on the idle screen and select "Widgets".
2. Different widgets will be displayed on the right side of the screen.
3. Select and drag the widget to the desired spot to be placed on the desktop. Please make sure there is enough space on the desktop. Otherwise, the widget will not be added.

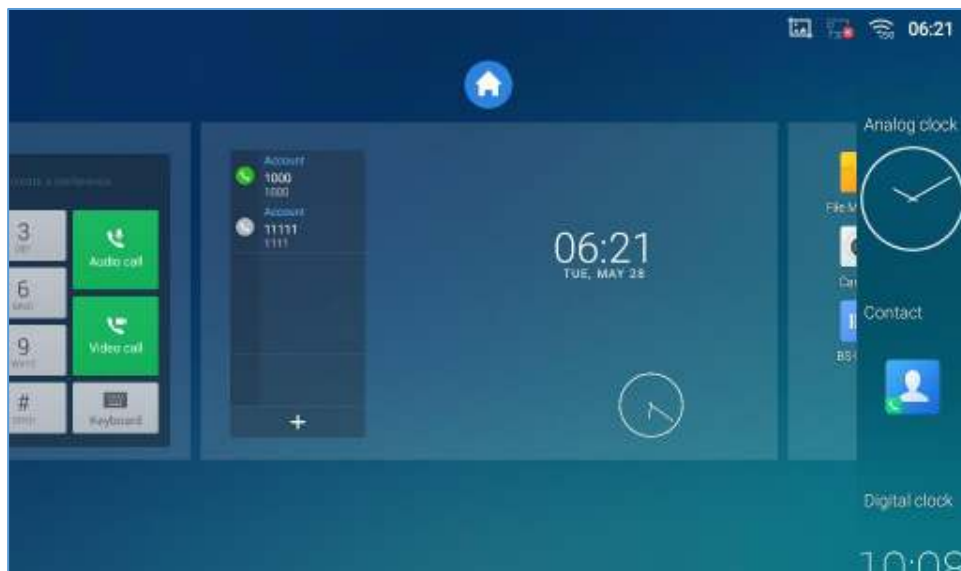

Figure 12: Add Widget to the Desktop

Manage Desktop Items

On the GXV3370 desktop, users could tap on the desktop items to manage shortcuts and widgets. The following operations can be done:

- **Tap on the shortcut icon to open the application.**

For example, tap on "File Manager" icon  to access file manager application.

- **Tap on the widget to open and edit it.**

For example, tap on the digital clock on the desktop. The clock settings will be brought up for users to set up timer, stopwatch, or alarm.

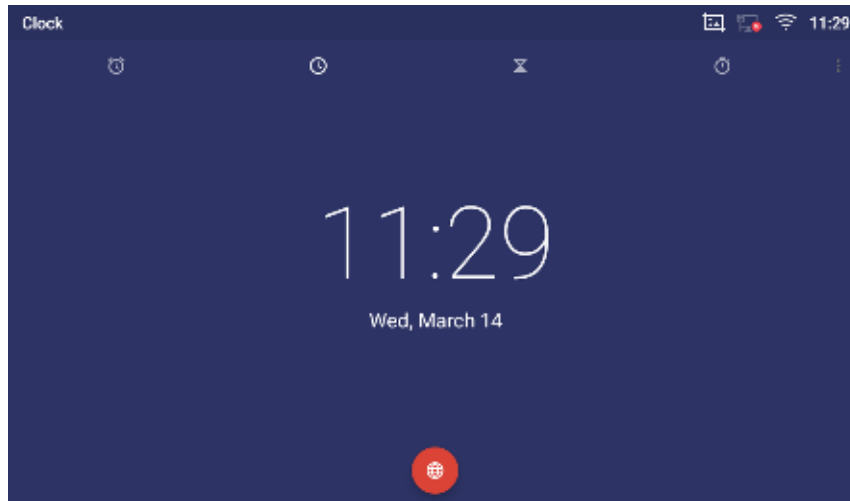

Figure 13: Open Clock Widget

- **Certain widgets such as the MPK Widget can be resized on the desktop.**

To resize a widget, press and hold the widget for about 2 seconds. Then lift your finger from the screen. This will bring up the white frame as shown in the following figure. Touch and drag the border of the frame to adjust the size.

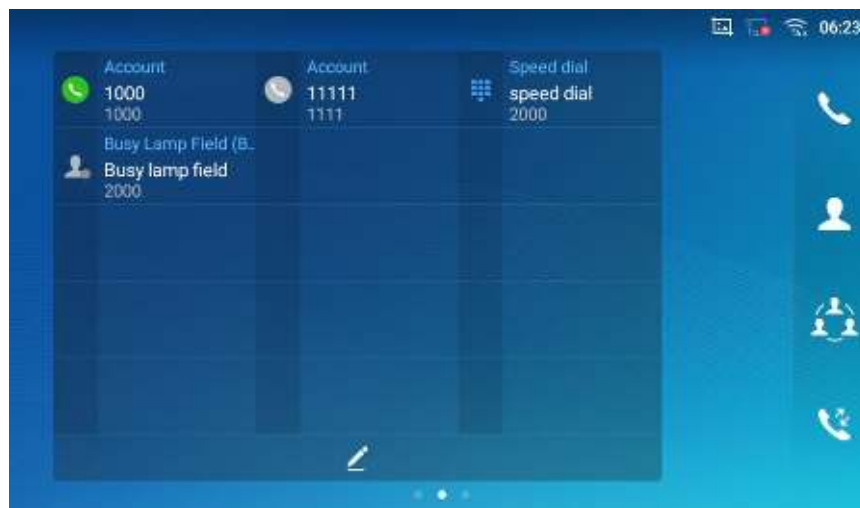

Figure 14: Resize MPK Widget

- **Move/delete Application/Widget**

To move a shortcut/widget to a different spot on the desktop or to a different idle screen, touch and press the item for about 1 seconds until a recycle bin icon shows up on the top of the screen. Drag the item up/down/left/right to the destination spot on the screen. Lift your finger once done. To delete the item/widget, press on it for about 1 seconds then move it to the recycle bin on the top of the screen.

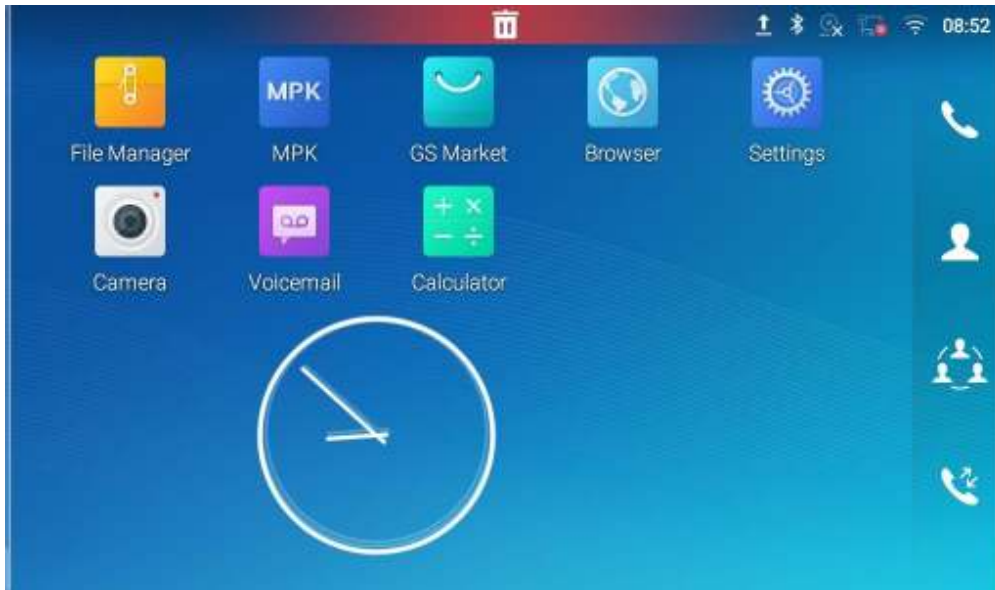

Figure 15: Move Clock Widget

- **Group Apps into folders on home screen**

To group different Apps in a folder, hold press on the app and drag it on top of the other app the folder will be created with a dark background showing icons of the Apps added.



Figure 16: Creating a Folder grouping Apps

Tap the folder to display the Apps included, you can rename the folder by touching the upper box to display the keyboard.

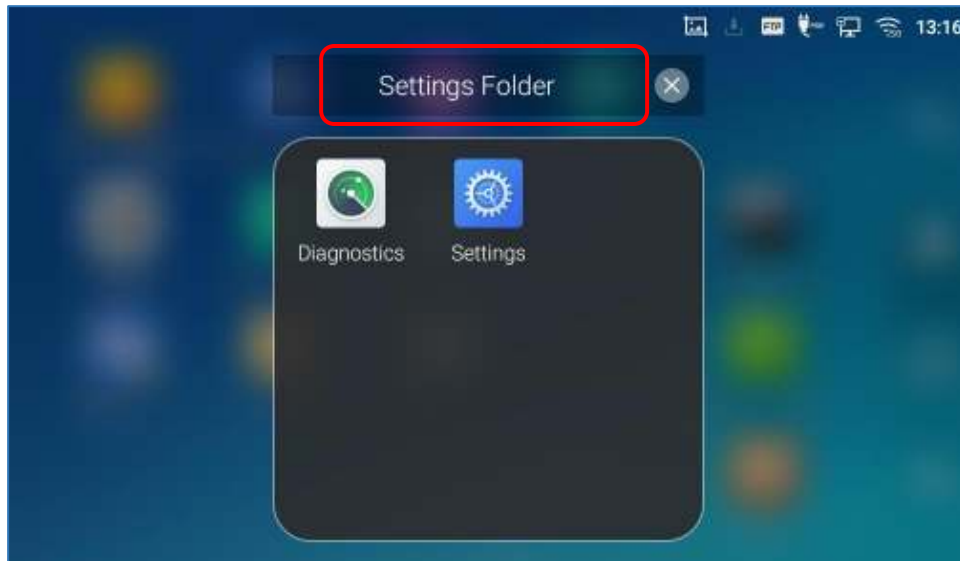



Figure 17: Renaming the Folder

Set Wallpapers

On the GXV3370 desktop, touch and press on an empty spot for about 2 seconds or users could press menu key  and select "Wallpaper" to set up the wallpaper for the desktop. Users could select wallpaper from different categories:

- **Local**
 Open Gallery application and tap on the picture to preview. Touch and drag the picture to adjust the frame that will be used as wallpaper. Then tap on "Set Wallpaper" to set the selected area of the picture as wallpaper.
- **Wallpapers**
 On the right side of the Wallpaper menu of the GXV3370. Select the picture from the default wallpapers available to preview and then tap on "Set wallpaper".

 **Note:**

Deleting an application icon will systematically pop up a window asking the permission to uninstall the application from the screen. Press ok to uninstall or press cancel to abort.

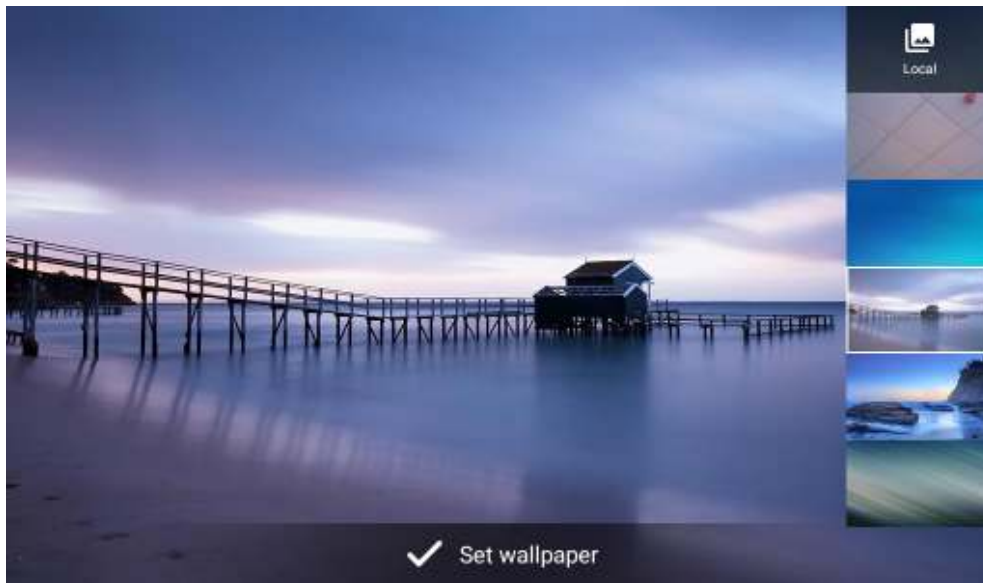



Figure 18: GXV3370 Choose Wallpaper

Set Weather Widget

On the GXV3370 desktop, touch and press on an empty spot for about 2 seconds or users could press menu key  and select Widgets to display available choices, Long press the Weather widget to add it to the desktop.

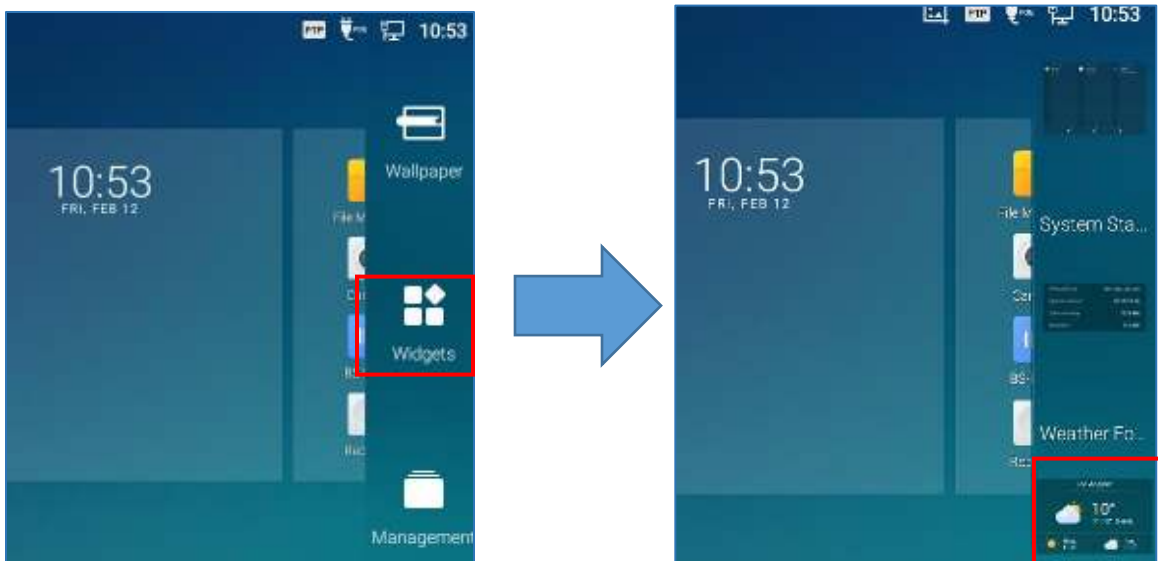

Figure 19 : Accessing available Widgets

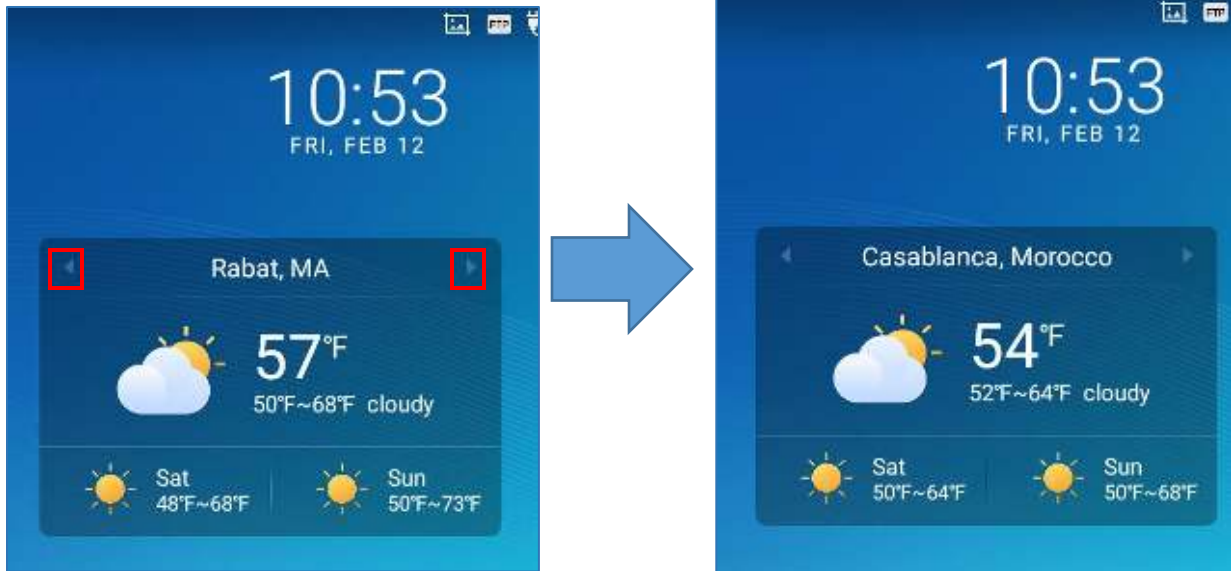



Figure 20 : Minimized display of Weather App

Use the Right/Left icons to switch between added cities on the minimized weather screen. Or when maximized use swiping movement to change between cities.



Figure 21: Maximized Display of Weather APP

Manage Running Applications

On the GXV3370 desktop, press an empty spot for about 2 seconds then select "Management" or select "Management" after pressing Menu button .

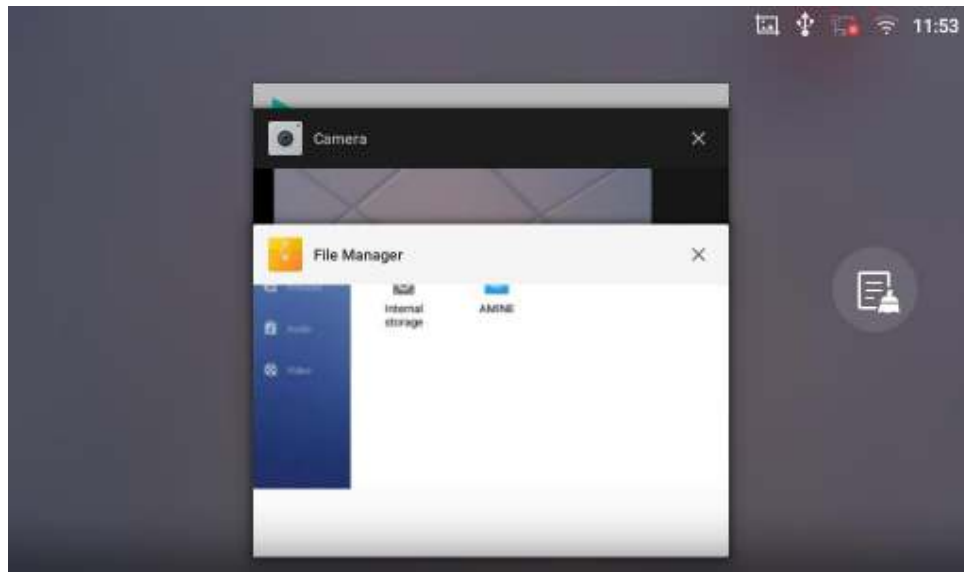



Figure 22: GXV3370 Recent Applications

Users could use the thread manager to do the following:

- Slide the running thread to the left or right to stop the application.
- Tap on icon  to delete all running threads.
- Tap on "Application" softkey to access application menu for advanced management options.

Idle Screen

Switch Idle Screens

The GXV3370 supports multiple idle screens by sliding the screen horizontally. On the GXV3370 screen, slightly touch an empty area and slide to the left or right using your finger to switch between different idle screens.

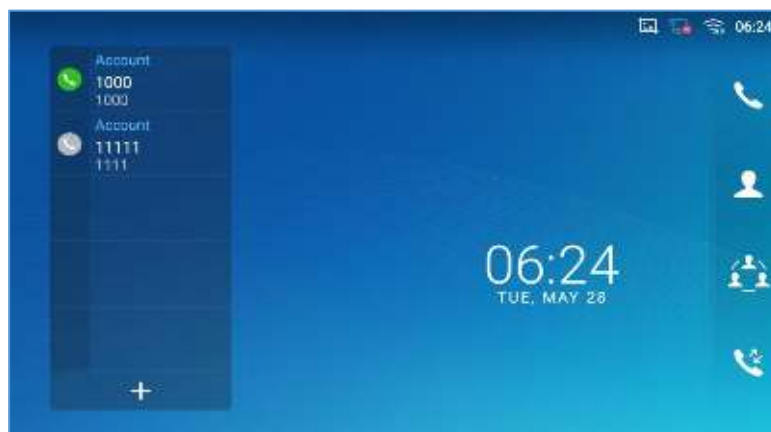

Figure 23: GXV3370 Switch Idle Screens

Set Up Idle Screen

- **Set home screen**

Follow the steps below to set up the HOME screen.





1. GXV3370 is up and running on idle screen.
2. Press the MENU button . This will zoom out all the screens as shown in **[Figure 24: Set up Home Idle Screen]**.
3. The screen with  displayed is the HOME screen. Others are shown with icon . Tap on the icon  to select the corresponding screen as the new HOME screen.



Figure 24: Set up Home Idle Screen

- **Add/Delete idle screen**

As shown in **[Figure 24: Set up Home Idle Screen]**, this section shows the available desktop screens. Users could add or delete idle screen.

- Add idle screen.

Tap on  to add a new idle screen.

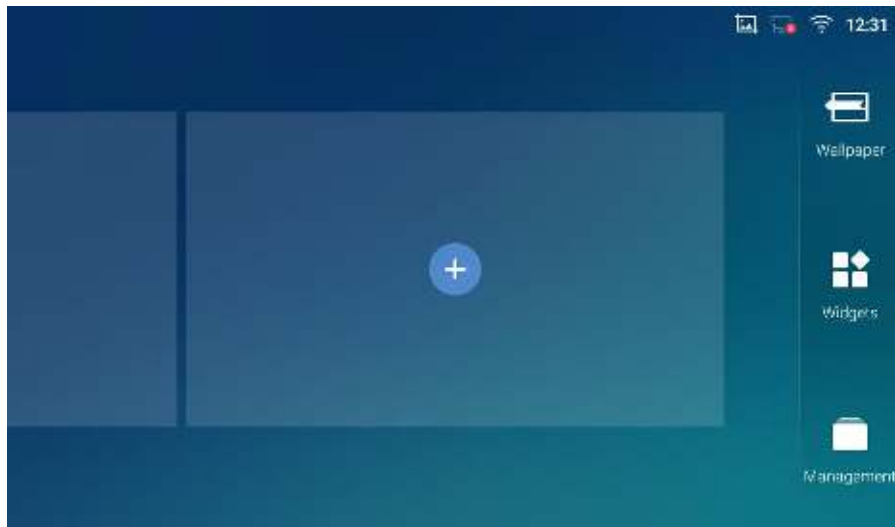



Figure 25: Add an Idle Screen

- Delete idle screen.

Tap on  to delete the Idle screen. Please make sure the apps, shortcuts or widgets on the idle screen are removed first. Otherwise, the  icon will not show for the idle screen.

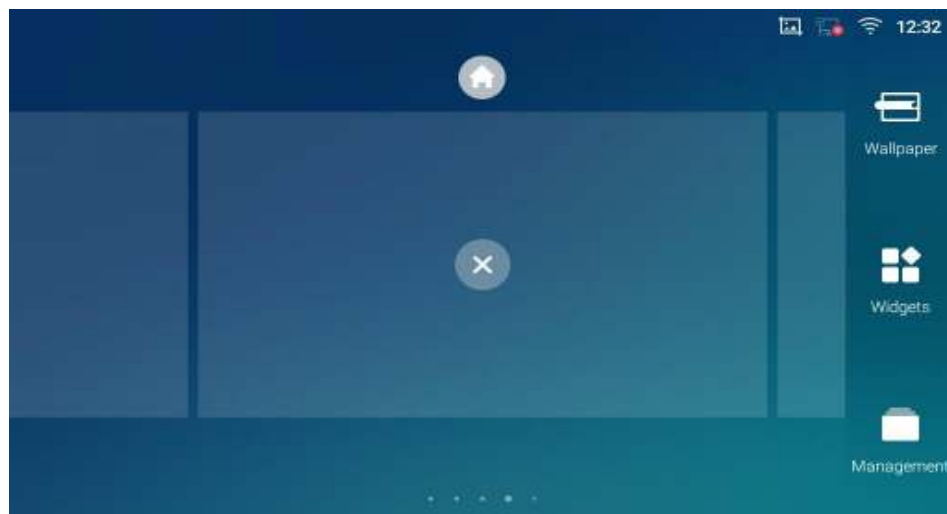

Figure 26: Delete an Idle Screen

Use the Status Bar

The status bar on the top of the GXV3370 screen provides visual notifications for the system settings and status, as well as quick access for important system settings. To access it, on the GXV3370 idle screen, slowly slide down from the top to the bottom of the screen as the following figure shows.

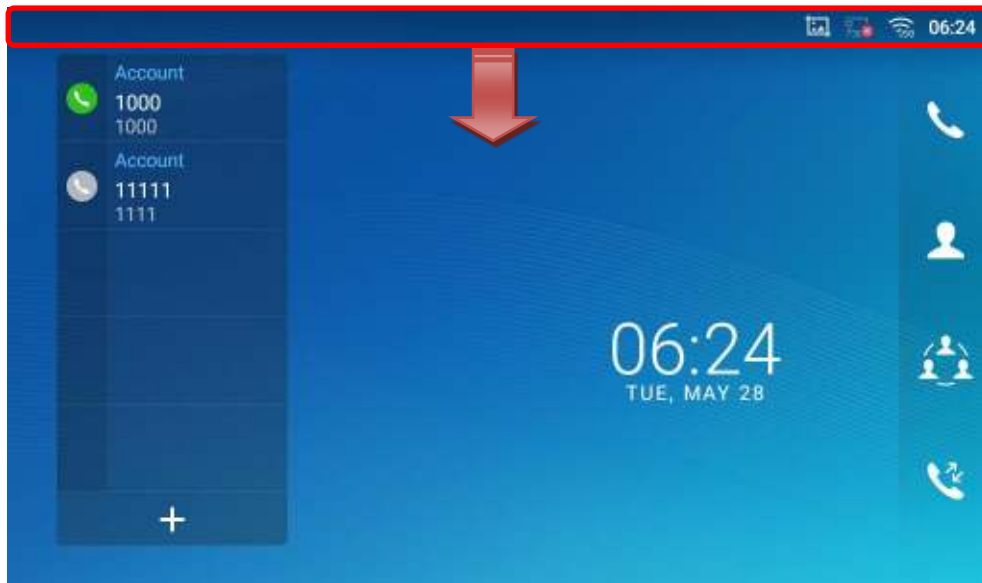

Figure 27: GXV3370 Top Status Bar

For more options on the Status Bar (brightness, call forward, RJ9 headset...) users can pull down the status bar twice, or once with two fingers.

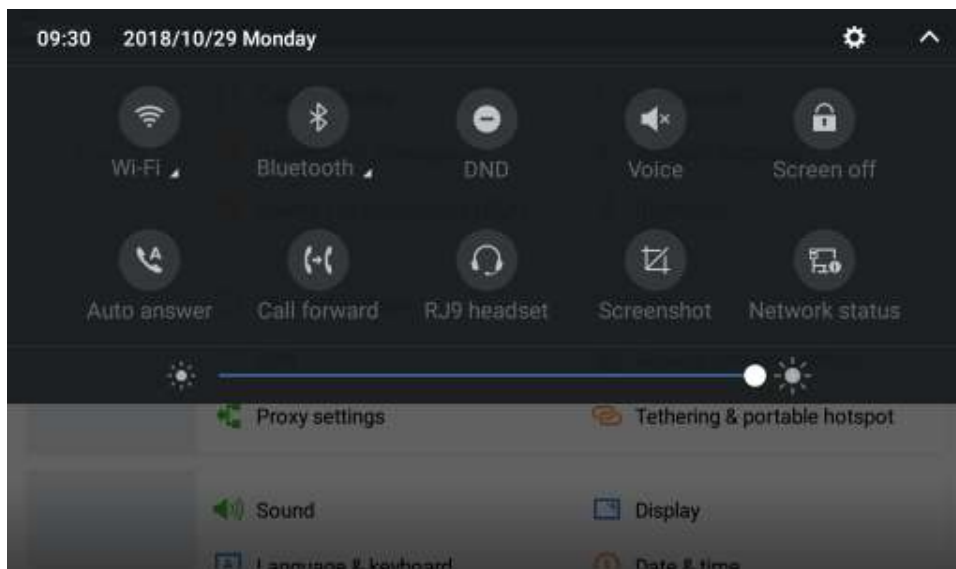

Figure 28: Status Bar - More Options

The running process and notifications will show up in the list. For example, the following figures indicate that there is a notification for an available Wi-Fi network.

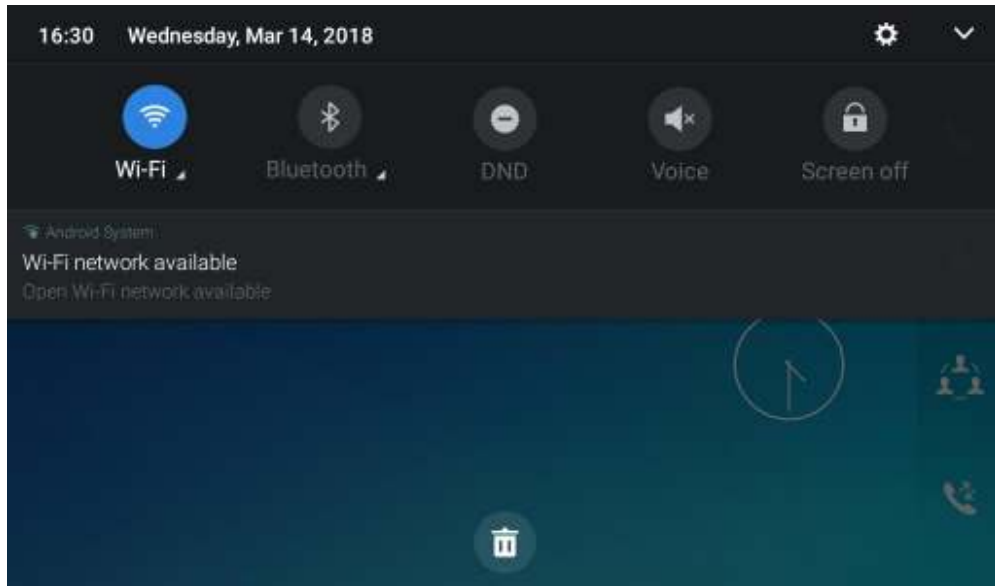

Figure 29: GXV3370 Top Status Bar – Notification

- Tap on the notification message to view the details.
- Slide the notification message to the left or the right side to remove it.

For more information about specific features in the notification bars, you can press the bottom right of the feature in question.

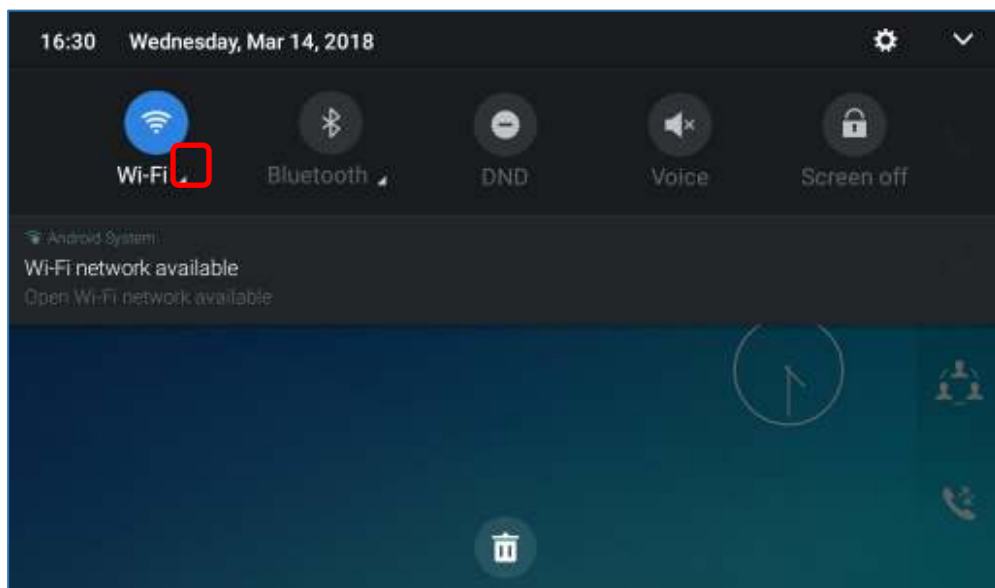

Figure 30: GXV3370 Top status Bar - Get more information

For example, you can see the available Wi-Fi Networks.

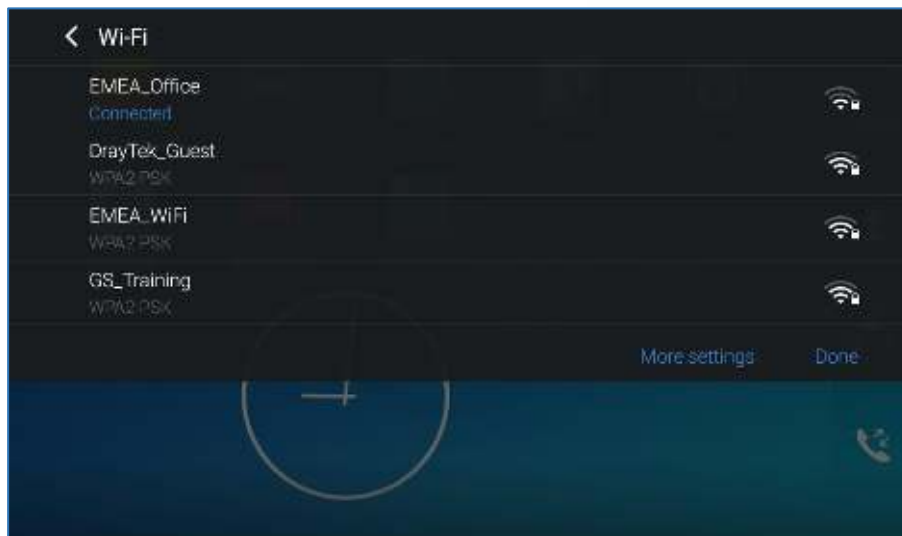































Figure 31: GXV3370 Top status Bar – Wi-Fi





Notifications in Status Bar

The following table describes the icons used on the status bar for notification purpose.

Table 7: GXV3370 Status Bar Notification Icons

	Network connected via Ethernet cable.
	Trying to connect to the network via Ethernet cable.
	Network disconnected via Ethernet cable.
	Handset is off hook.
	Speaker is being used. (x)
	RJ9 headset is connected.
	RJ9 headset is being used for calls.
	3.5mm earphone is connected.
	3.5mm earphone is being used for calls.
	Wi-Fi is enabled and still not connected.

	Wi-Fi network is available.
	Wi-Fi is enabled and connected.
	Onscreen keyboard is activated.
	Bluetooth is enabled but not connected.
	Bluetooth is enabled and connected.
	Bluetooth headset is connected.
	Bluetooth headset is being used for calls.
	Downloading files via Bluetooth.
	Alarm is set up and enabled.
	DND is enabled.
	Silent mode is enabled. When it is on, the incoming call/message will not produce ring tone/notification tone from phone's speaker.
	SD Card is inserted.
	SD Card space full.
	USB flash drive is inserted.
	Downloading files via Internet connection.
	Unread voicemail to be retrieved.
	Incoming call from blacklist contact.
	Camera is disabled.
	Contact storage is full.
	HDMI cable is connected to display device.

	The phone is powered up using PoE.
	Call forward is set up.
	PPPoE is connected.
	PPPoE is not connected.
	Warning message.

System Settings in Status Bar

Slide down the top status bar and select **System Settings**. Users will see the following settings.

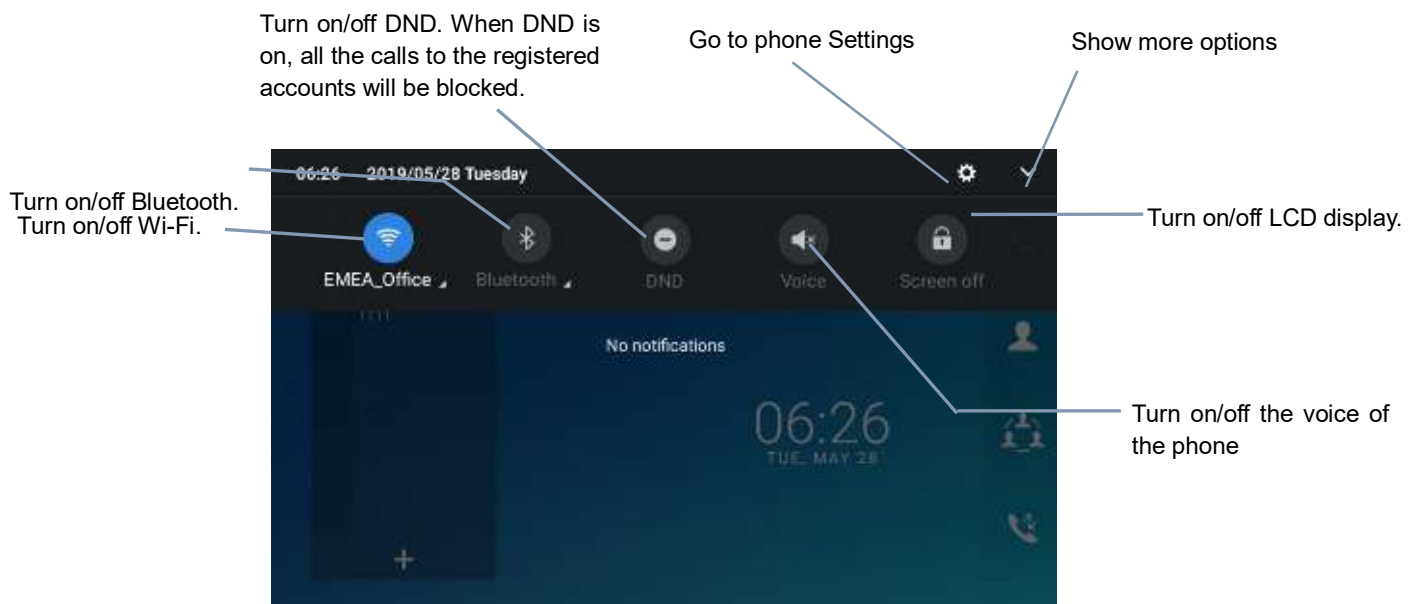

Figure 32: System Settings in Status Bar

Use the GXV3370 Keys

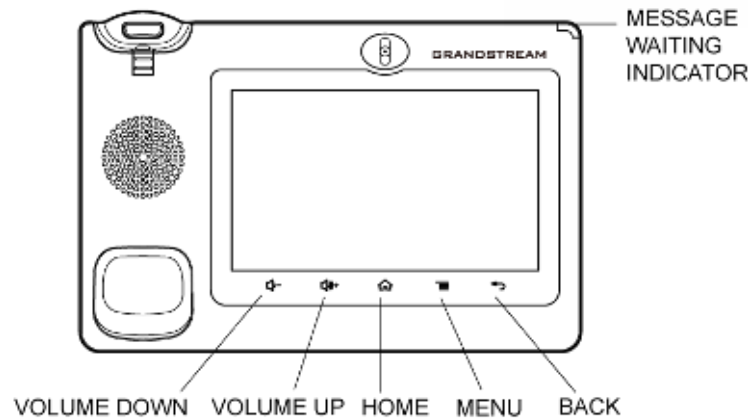

Figure 33: GXV3370 Keys

Table 8: GXV3370 Keys

Volume Down	Tap to turn down the call volume and media volume.
Volume Up	Tap to turn up the call volume and media volume.
Home	Tap to go back to Home screen; or touch and press for about 2 seconds to take a screenshot
Menu	Tap to view options for different screens or applications.
Back	Tap to go back to the previous menu.

Keypad Shortcut Functions

The GXV3370 supports keys shortcuts for certain special system functions.



- **Screenshot**

Press and hold the Home button  for about 2 seconds to capture screenshot. The screenshot can be accessed via **File Manager**→ **Pictures**. The screenshot picture size is 1024x600 pixels.

- **Firmware upgrade via SD card**



For users that could not use remote upgrade or could not access the phone's Web GUI to upload firmware, upgrading via external SD card is an alternative. Follow the steps below to upgrade GXV3370 via SD card.

1. Download the firmware file to PC and save it in SD card.
2. Insert the SD card to GXV3370.

3. Power cycle the GXV3370.
4. Wait for the LED in the upper right of the phone to light up in Green, then about 2 seconds later press the both keys  (the first LCD key from the left : Volume Down) and  (the third LCD key from the left : Home) at the same time, it will go into the upgrading process.
5. The GXV3370 will start upgrading and display the upgrading process in the screen.
6. Wait until the upgrading is done.
7. The GXV3370 will reboot itself.
8. Check the firmware status and remove the SD card.

- **Hard reset**

For users that want to factory reset the device manually, hard reset is an alternative:

1. Power cycle the GXV3370.
2. Wait for the LED in the upper right of the phone to light up in Green, then about 2 seconds, press the both keys  (the second LCD key from the left: Volume Up) and  (the 4th LCD key from the left : Menu) at the same time, it will go into the factory reset process.
3. The LCD screen will display “Factory reset, please wait”.
4. The GXV3370 will reboot with factory default settings.



Note:

Upgrading via USB storage device is not supported on the GXV3370.

Use the On-Screen Keyboard

The GXV3370 onscreen keyboard can be activated by tapping on an input field.

- **English Keyboard**

This is the default keyboard on GXV3370.



Figure 34: GXV3370 Onscreen Keyboard - English Keyboard



To switch input between lowercase and uppercase, tap on  (lowercase) or  (uppercase).



Figure 35: GXV3370 Onscreen Keyboard - Lowercase and Uppercase

- **Number and symbols**



To input number and symbols, tap  on the default keyboard to switch to number/symbols. Tap on  to switch back.



Figure 36: English Keyboard - Number and Symbols

Tap on  to access more symbols.



Figure 37: English Keyboard - More Symbols







 **Note:**

- To configure keyboard and input methods options, please refer to the following steps:
 1. Go to **Settings**→**Basic**→**Language & Keyboard**→**Virtual Keyboard**
 2. Click on “+” to add more input method.
 3. Go to **Settings**→**Language & Keyboard**→**Current Keyboard** and choose from the input methods.
 4. After these steps, the method would change to the new one.
- Users could touch and press the key on the keyboard for about 2 seconds to input the alternative character. For example, touch and press the “+” key for about 2 seconds can get the selection “±”.

Use the Message Waiting Indicator

The GXV3370 message waiting indicator LED is on the upper right corner of the device. It could notify the users with different messages and status of the phone. Please refer to the status description below. **The priority for the LED indicator is from high to low in the following table.**

Table 9: GXV3370 MWI LED Status

Color	LED Status	Description
	Fast Flashing	Incoming call
	Solid	Calling, Talking, Conferencing, Screensaver on when the LCD is off
	Slow Flashing	A call is on hold
	Flashing	Missed call (s), New voicemail (s), New SIP Message (s)
	Solid	High memory usage, Maximum contact storage, Network disconnect
	Fast Flashing	Upgrading
OFF	OFF	Normal

MAKE PHONE CALLS

Register SIP Accounts

The GXV3370 supports up to 16 independent SIP accounts. Each account can have separate SIP servers, usernames, and NAT configurations.

Account Status

On the idle screen, the account widget shows the account name, and registration status.

- The following figure shows the account is successfully registered (account icon is green).
- If the account icon is grey, it is still trying to register or unable to register.

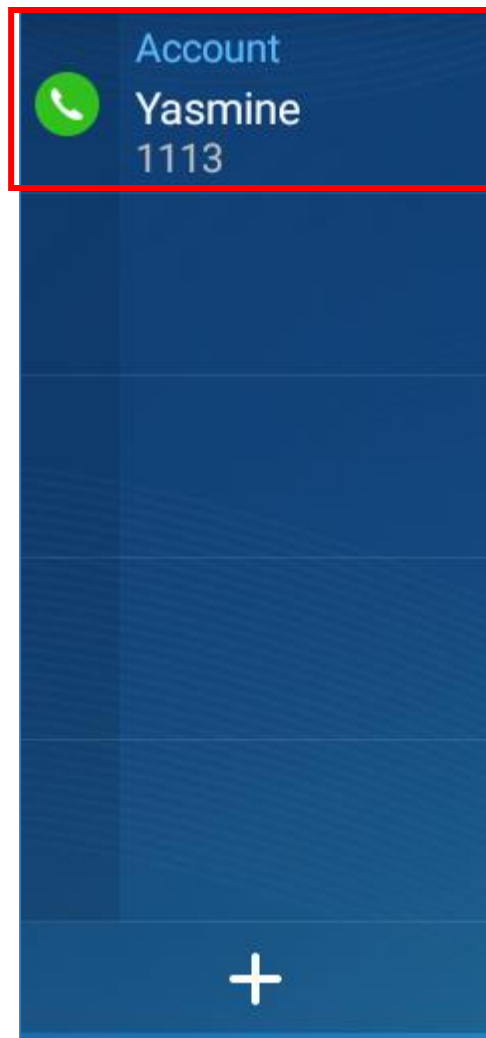

Figure 38: GXV3370 Account Widget

Configure SIP Account

To register a SIP account, users can access phone's LCD menu → **Settings** → **Advanced** → **Account Settings**

Or users could log in the GXV3370 web GUI → **Account** page to fill in the necessary registration information, i.e., Account active, Account name, SIP Server, SIP User ID, SIP Authentic ID, SIP Authentic Password, etc. Once the correct information is entered and saved, the account registration status will show on the main screen.

Note:

For web GUI login and configuration information, please refer to GXV3370 Administration Guide.

If the account is successfully registered, users could use one of the following ways to bring up dial screen to start making calls.

- Take the handset off hook.
- Select an account from the account widget in the idle screen.
- On the shortcuts menu of the idle screen, tap on  icon to open dial screen.

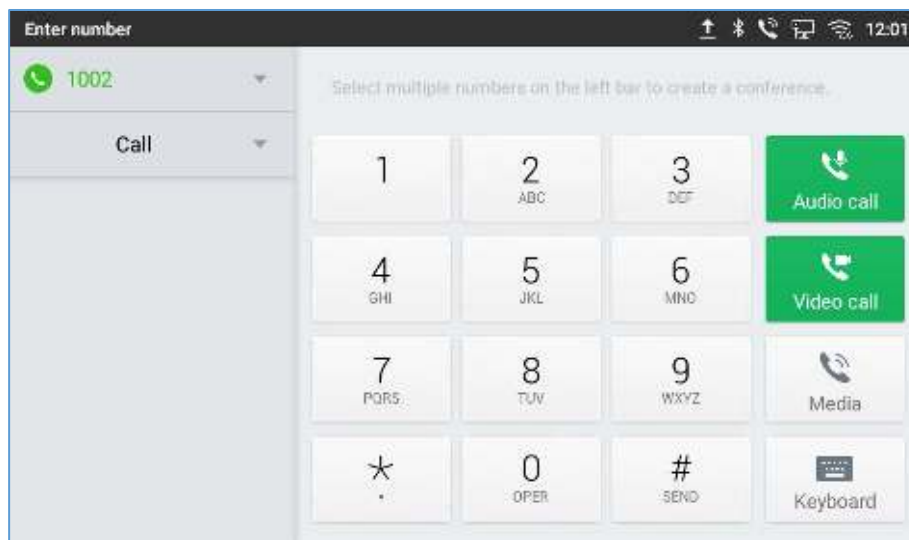

Figure 39: GXV3370 Dial Screen

If **Enable Video Call** option is disabled, the **Video Call** option on GXV3370 dial screen will not be available

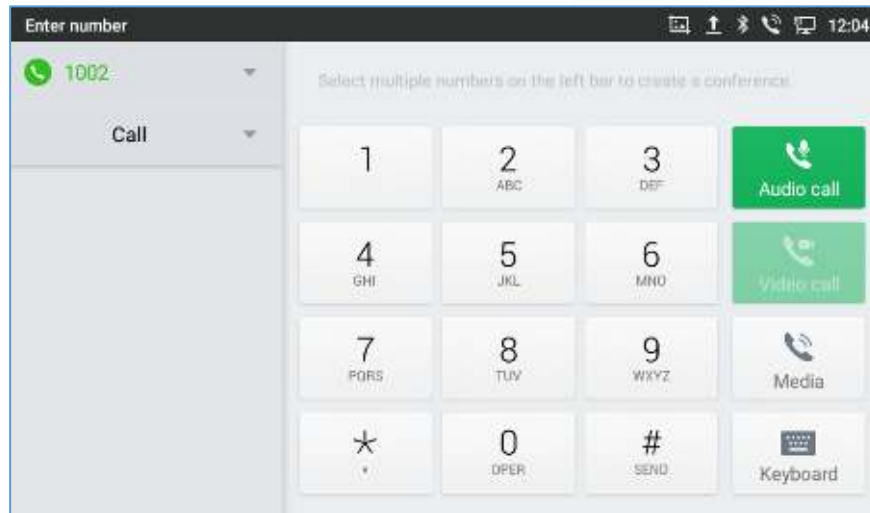



Figure 40: Disable Video Call Feature on Dial Screen

Dial a Number Directly

1. Use the methods mentioned above to open dial screen [\[Figure 39: GXV3370 Dial Screen\]](#).
2. Select the account to dial out on the left panel of the dial screen. The selected account will be displayed in green
3. Choose the call mode to be used (call, paging, or IP call), the call mode used will be displayed under the account.
4. Enter the digits to be dialed out using the keypad. If the digit matches call history, a list of numbers will be displayed for users to select from.
5. Tap on  (audio call only) or  (video call) to send the number. If no key is pressed, by default the call will be automatically dialed out after 4 seconds timeout.

Note:

- By default, the "No Key Entry Timeout" is 4 seconds, meaning if no key is pressed after entering a number, the call will be automatically sent out after the timeout. The timeout interval can be configured under web GUI→**Account**→**Call Settings**.
- GXV3370 allows users to press # key as SEND key. This behavior can be disabled via option "Use # as Dial Key" under web GUI→**Account**→**Call Settings**.
- When the user enters the digit on the dial screen, if there is digit matching call history, or contacts name/number, the drop-down list will show the numbers. For example, if "John" is saved in the contacts, entering 5 (JKL) 6 (MNO) 4 (GHI) 6 (MNO) will show call log with 5646 as the first four digits, as well as John's number. Users could then directly select one of them from the list, instead of entering all the digits.



Redial

Users can dial out the last dialed number if there is dialed call log, using the same SIP account making the call last time.

1. Enter the dial screen.
2. A list of dialed calls will be displayed on the left side of the dial pad. Tap on the number you would like to call, the number will be added to the dialing field, press Audio call or Video call to redial.

Dial a Number via Contact

Follow the steps below to dial a number via Contact.

1. Access Contacts by tapping on  icon on the left side of the idle screen.
2. Navigate in the contacts entries by sliding up/down on the screen.
3. Tap on the dial icon for the contact .

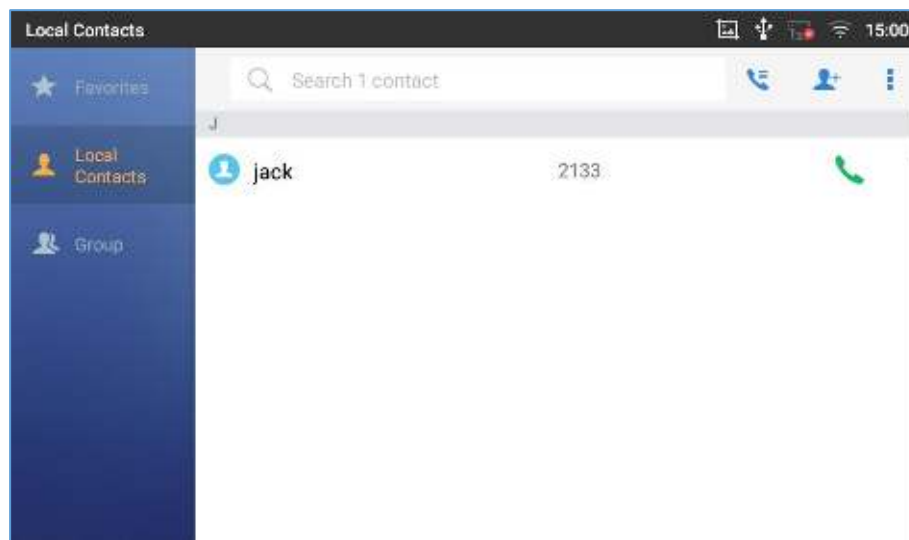



Figure 41: GXV3370 View Contacts

Dial a Number via Call History

1. Access Call History by tapping on  icon on the bottom of the idle screen.
2. The LCD will display all call history types: "All", "Missed", "Outgoing" and "Incoming" calls.
3. Navigate in the call history list by selecting the call history category and sliding up/down on the screen.
4. Tap on the entry to show more details or tap on  to dial out.

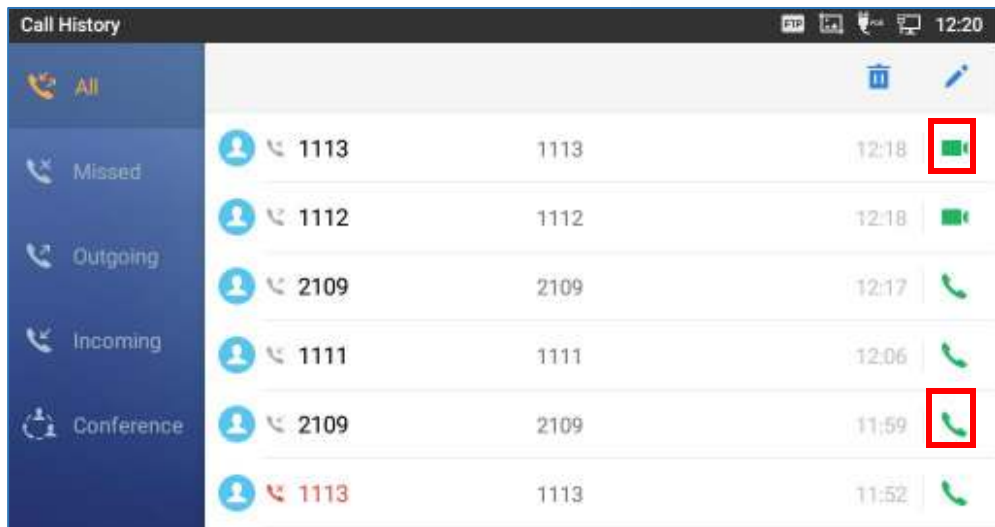



Figure 42: GXV3370 Call History

Note: The icon next each call indicates the Call Type with which the call was made, icon  means this was a Video call. Moreover,  means it was an Audio call.

In order to select which call mode to use when calling from Call History, access the call Details, then press the icon with keypad to dial the number on the phone's keypad directly and then select whether to use Audio or Video Call to begin the call.

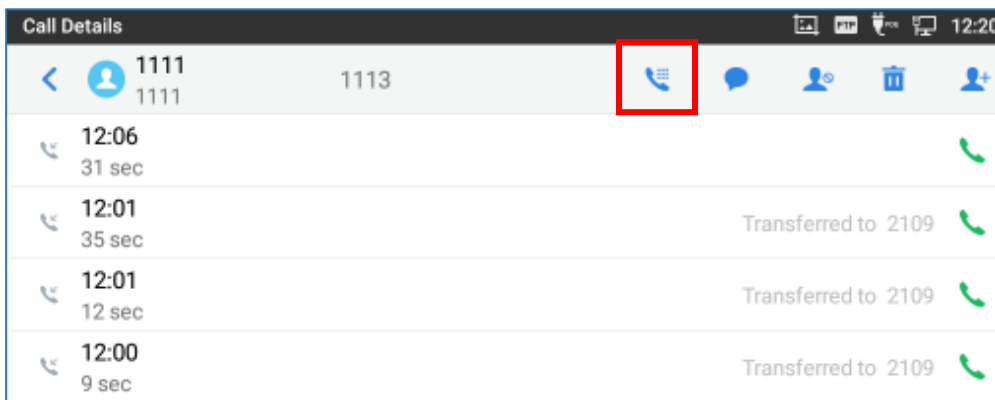

Figure 43 : Call Details





Figure 44: Select call Mode Audio or Video Call

Direct IP Call

Direct IP Call allows two phones to talk to each other in an ad-hoc fashion without a SIP proxy. VoIP calls can be made between phones if:

- Both phones have public IP addresses, Or
- Both phones are on the same LAN/VPN using private or public IP addresses, Or
- Both phones can be connected through a router using public or private IP addresses (with necessary port forwarding or DMZ).

To make a direct IP call, please follow the steps below:

1. Off hook the phone or select account in the idle screen to bring up dial screen on GXV3370.
2. Set the call mode as "IP Call".
3. Input the target IP address. For example, if the target IP address is 192.168.0.116 and the port is 5062 (i.e., 192.168.0.116:5062), input the following:
192*168*0*116#5062. The * key represents the dot (.) and the # key represents the colon (:).
4. Press on  (audio call only) or  (video call) to dial.

Answer a Call

Single Incoming Call

- When the phone is in idle and there is an incoming audio call, the phone will show the call screen as below. Tap on "Answer" softkey to answer the call via speaker or pick up the handset the answer the call.



Figure 45: Single Incoming Call – Audio

- When the phone is in idle and there is an incoming video call, the phone will show the call screen as below. To answer the call with audio only, tap on "Audio" to answer the call via speaker. To answer the call with both audio and video, tap on "Video". During video call or pick up the handset, the audio will switch to handset if picking up the handset.

Note: Users could select the **Video Display Mode** on phone's Web UI→**Phone Settings**→**Video Settings**. Set the video display mode to "**Original proportion**", "**Cut proportionally**" or "**Add black margin proportionally**".

If set to "**Original proportion**", the phone displays video in its original proportion. If the video display proportion is different from the one on the phone, the phone will stretch or compress video to display it. If set to "**Cut proportionally**", the phone will cut video to meet its own display proportion. If set to "**Add black margin proportionally**", the phone will display video in its original proportion, if still exists spare space, the phone will add black edge on it.



Figure 46: Single Incoming Call – Video

Preview Function for Incoming Call

- If the phone set the “Preview” feature for the incoming call from Web UI, the phone will display one more key “Preview” when there is an incoming video call. End users will preview the remote end without answering the video call. After previewing, end user can tap on Answer key to answer the video call, or “Reject” key to reject it. This feature should be supported by the SIP server. Please contact service provider for more information.



Figure 47: Single Incoming Call – Preview-1



Figure 48: Single Incoming Call – Preview-2

Transfer Function for Incoming Call

- If the phone set the “Transfer” feature for the incoming call from Web UI, the phone will display one more key “Transfer” when there is an incoming call. End users will have the possibility to transfer the call without answering. After pressing “Transfer” button, end user can enter manually destination or

press “MPK” to select a destination. “Reject” key to reject it. This feature should be supported by the SIP server. Please contact service provider for more information.

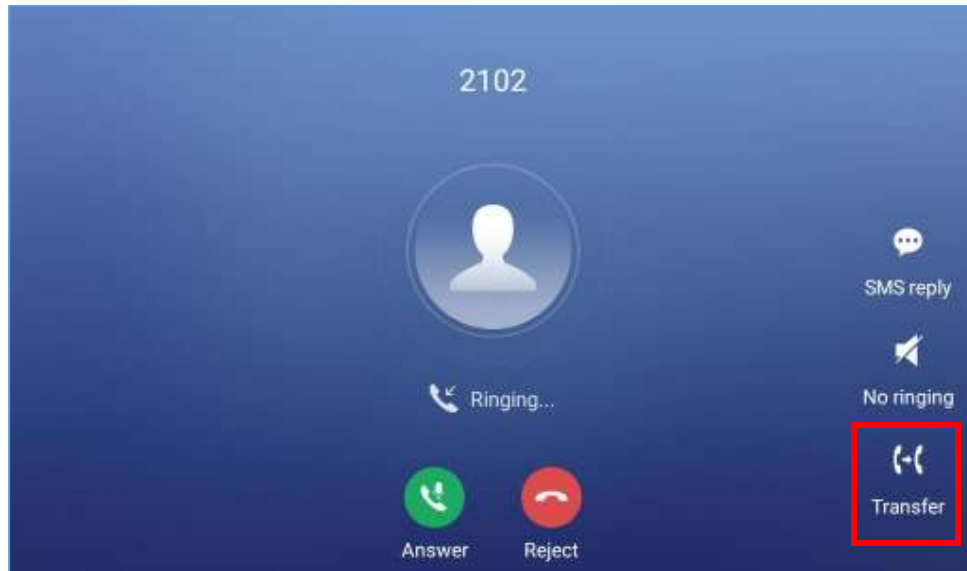

Figure 49: Single Incoming Call – Transfer-1

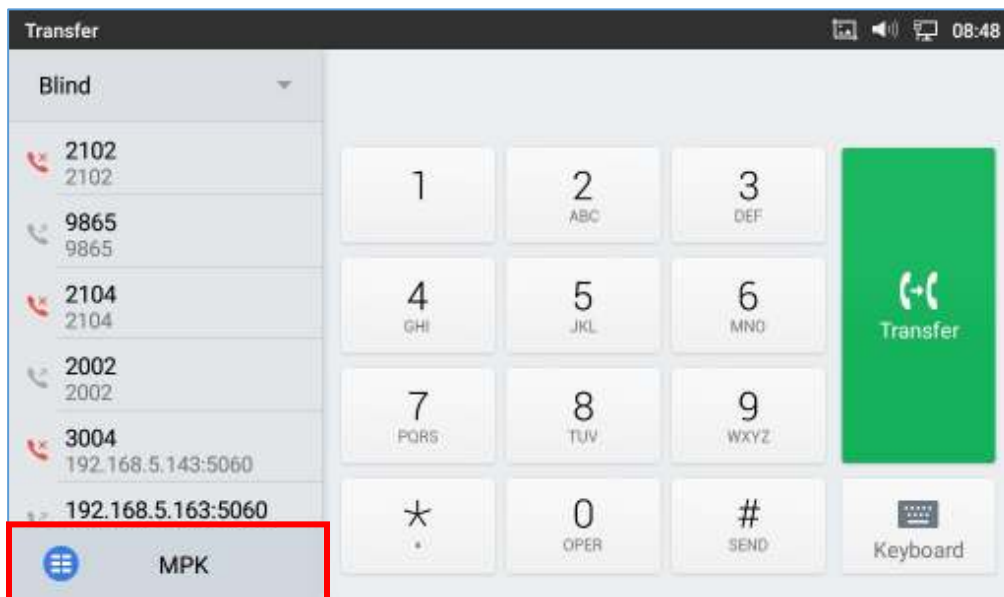

Figure 50: Single Incoming Call – Transfer-2

Multiple Calls/Call Waiting

1. When there is another incoming call during active call, users will hear a call waiting tone, with the LCD displaying the caller name and ID for the incoming call. In the prompt window, it shows new incoming call from "Jack" with the caller number; the account bar in purple is the current active call with "1004".



Figure 51: Call Waiting

2. Similar to single incoming call, if the incoming call is video call, users can choose to Audio Answer or to Video Answer
3. Once the new call is answered, the current active call will be placed on hold. If the new call is rejected by tapping on "Reject" softkey, the current active call will not be interrupted.

Call Progress Status

During an active call if Home Button is pressed, the phone will go back to the home screen and the call-in-progress status will be shown on the GXV3370 status bar, once clicking the bar it will go back to call screen.

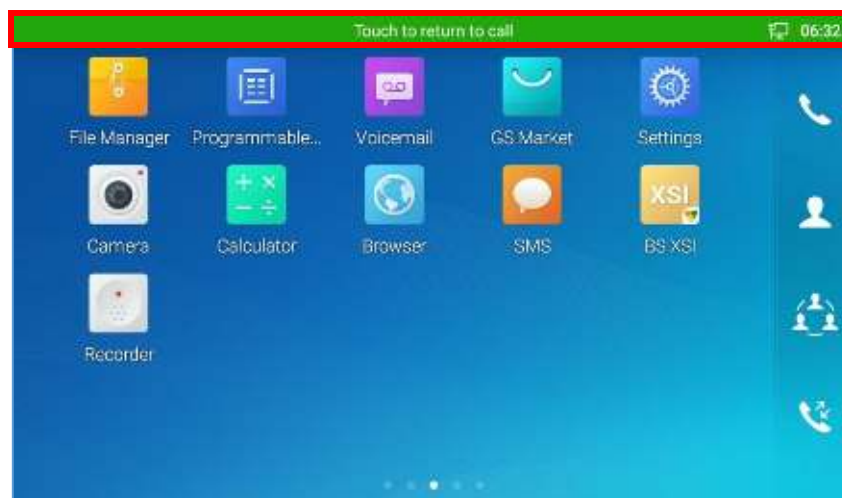

Figure 52: Touch to Return to Call Screen

Call Hold

During the active call, press HOLD softkey under “More” →”Hold”. The LCD screen will show as below. To resume the call, press UNHOLD softkey on the bottom of the screen.

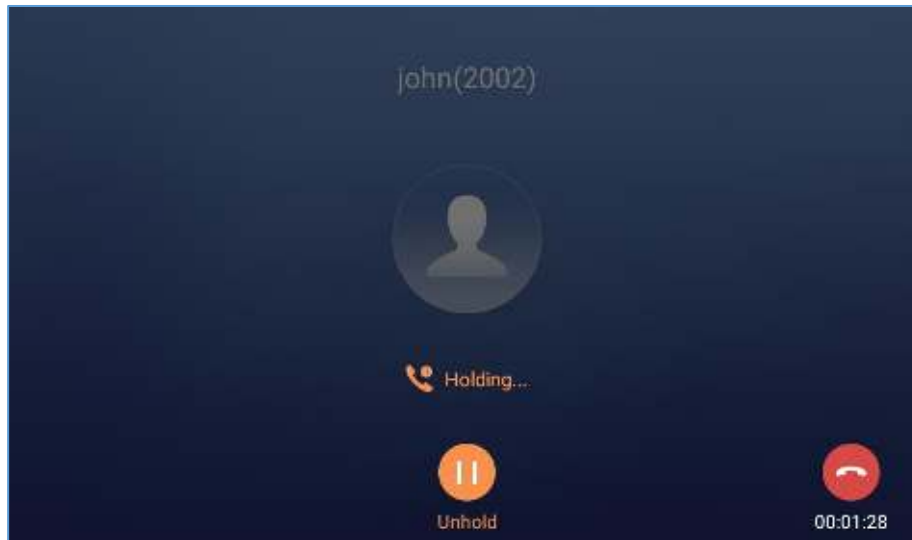

Figure 53: Call on Hold

Call Recording

1. During the call, users could record the conversation to the phone by tapping on “Record”
2. If need to stop the recording, tap on “Stop Recording”
3. The recording files can be retrieved from the GXV3370 Recorder application

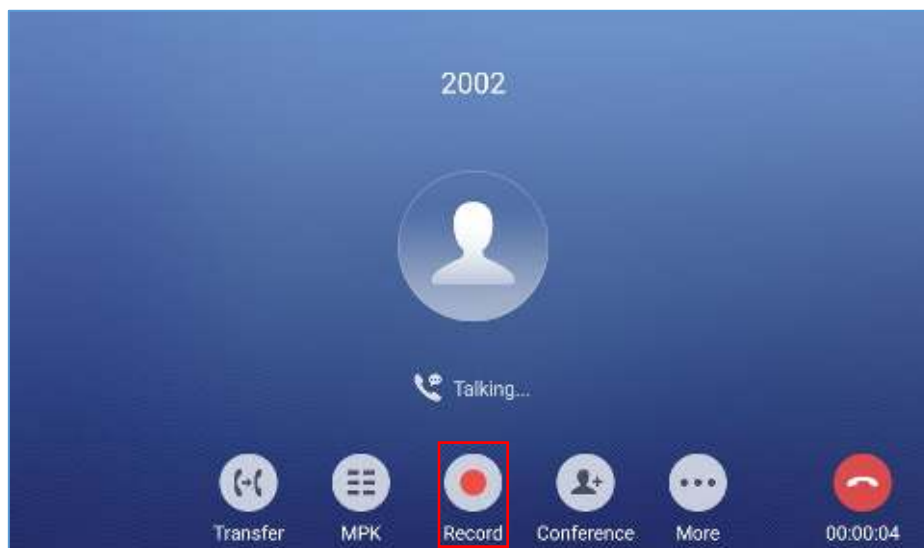

Figure 54: GXV3370 Call Recording

MPK Monitoring

During the call, users could view and monitor the programmable keys configured for the current Account:

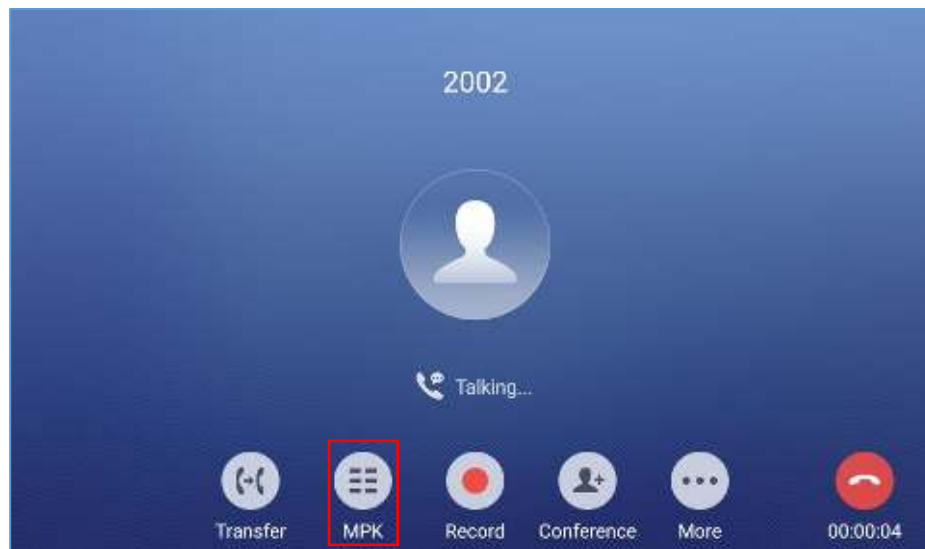

Figure 55: MPK button

1. During the Call, press the MPK button as shown above.
2. The list of MPK configured for the active account will be displayed.

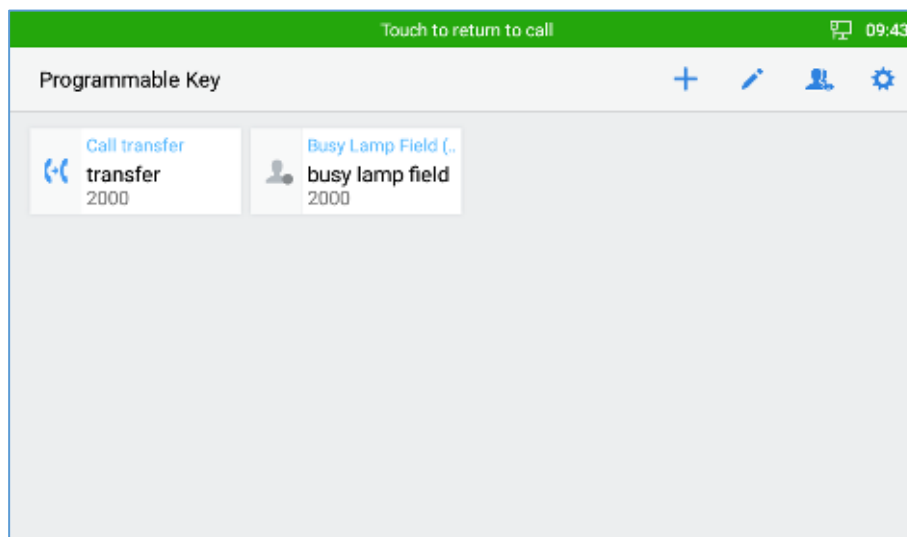

Figure 56: MPK list

3. User can choose an MPK from the list as they see convenient

Mute

During an active call, press **"More"** → **"Mute"** to mute the call. The mute icon  will be displayed in the status bar on the top of the screen. Press **"More"** → **"Unmute"** to unmute the call.



Figure 57: GXV3370 Call Mute

Turn on Video during Audio Call

Users could establish audio call first and then turn on video or accept video request during the call if the other party supports video call as well.

- **Turn on video during audio call**

During an active audio call, on the call screen, tap on "More" and select "Video On", a video request will be sent to the other party.

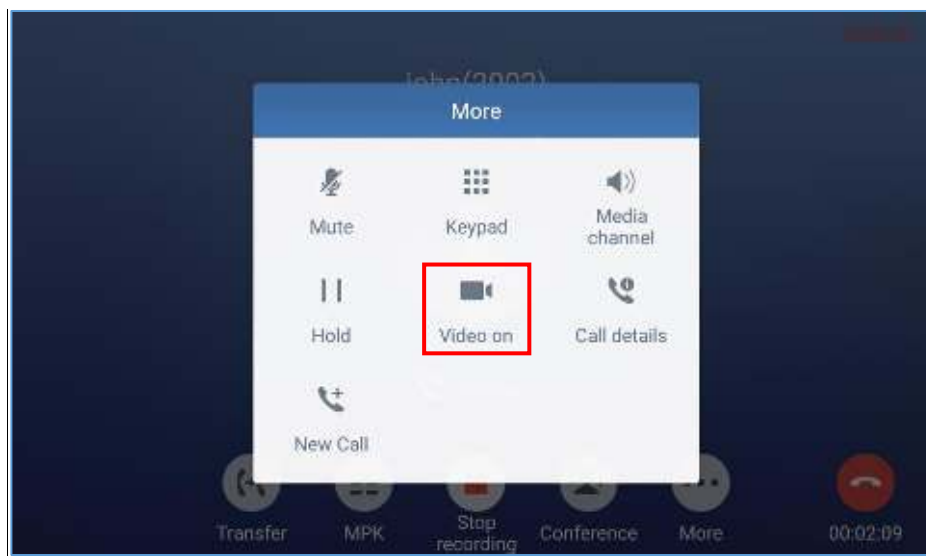

Figure 58: Turn on Video During Audio Call

- **Accept video request**

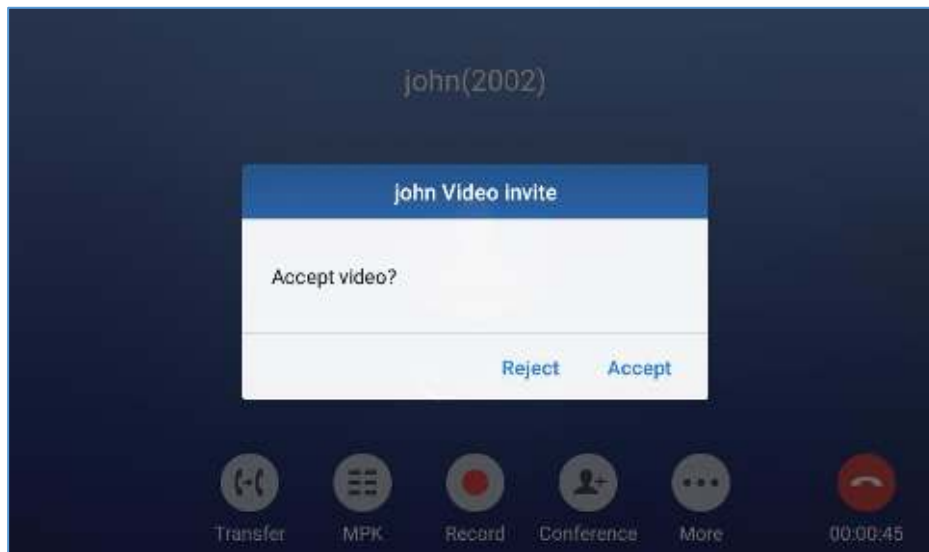







Figure 59: Accept Video During Audio Call

If the GXV3370 receives video request during the audio call, a message "Do you want to accept video?" will be prompted. Select "Yes" to establish video during the call. If the **Enable Video Call Feature** is not enabled on GXV3370, the "Video On" option on GXV3370 will be hidden during the audio call. However, if the GXV3370 receives video request during the audio call, users could tap to accept the video request.

Switch Audio Channel During Call

- The GXV3370 allows users to switch among handset, speaker, or headset (RJ9 headset, 3.5mm earphone, Plantronics EHS headset and Bluetooth headset) when making calls.
- During a call, tap on the first softkey on the bottom to switch audio channel. Tap on icon  to use handset; tap the icon  to switch to RJ9 headset; tap on icon  to switch to speaker; tap on  to switch to 3.5mm earphone; tap on  to switch to Bluetooth headset.
- If Bluetooth headset is connected, the audio will be automatically switched to Bluetooth headset once the call is established.
- The status bar on the top or the screen shows the current audio channel being used during the call.

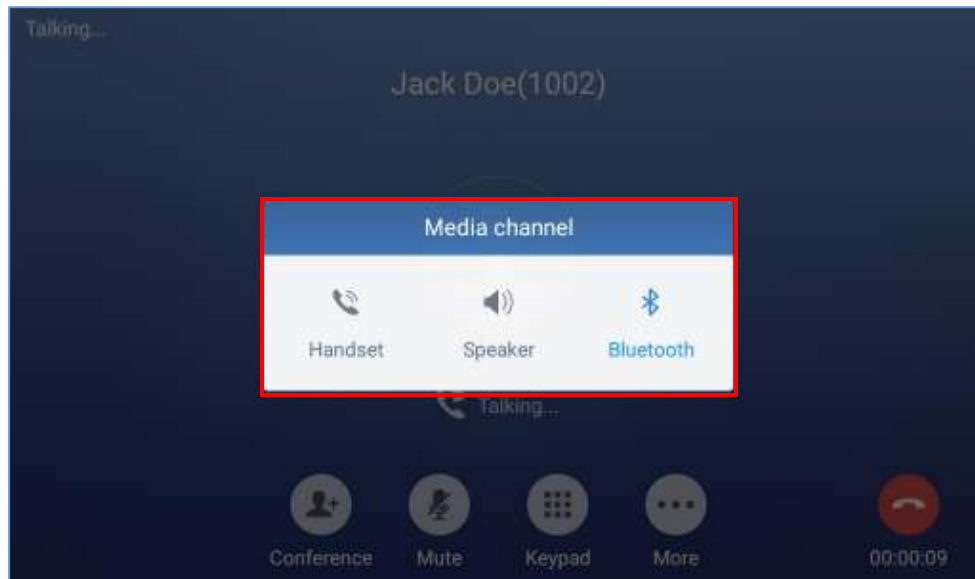

Figure 60: Switch Audio Channel during Call

Call Transfer

A call can be transferred to another party during the call. The GXV3370 supports blind transfer and attended transfer.

Blind Transfer

1. During the active call, tap on "More" softkey.
2. Select "Transfer" to bring up the transfer screen.
3. Select transfer mode as "Blind" by tapping on the highlight area in **[Figure 61: Blind Transfer]**. The default transfer mode is "Blind".
4. Enter the digits.
5. Tap on "Transfer" softkey.
6. The call will be transferred and GXV3370 will hang up the call.

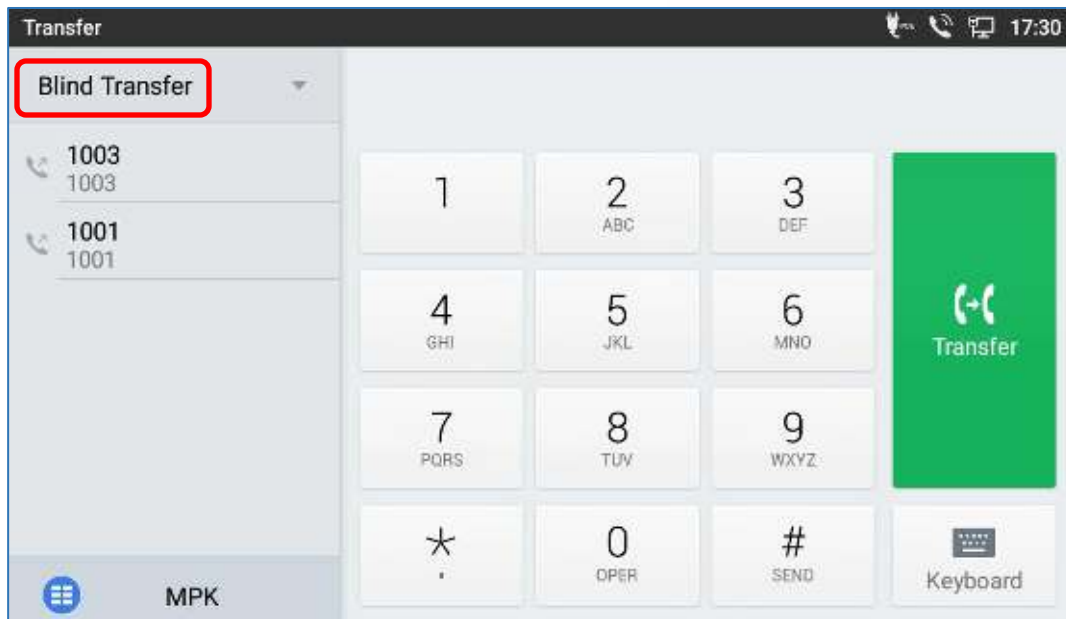



Figure 61: Blind Transfer

 **Note:**

- If wrong digits are entered, tap on  to delete the digit one by one;
- If users would like to cancel the transfer, press  button to go back to the previous talking screen.

Attended Transfer

GXV3370 supports attended transfer:

1. During the active call, tap on **"More"** softkey. Select **"Transfer"** to bring up transfer screen.
2. Select transfer mode as "Attended" by tapping on the mode selection area (see figure below).

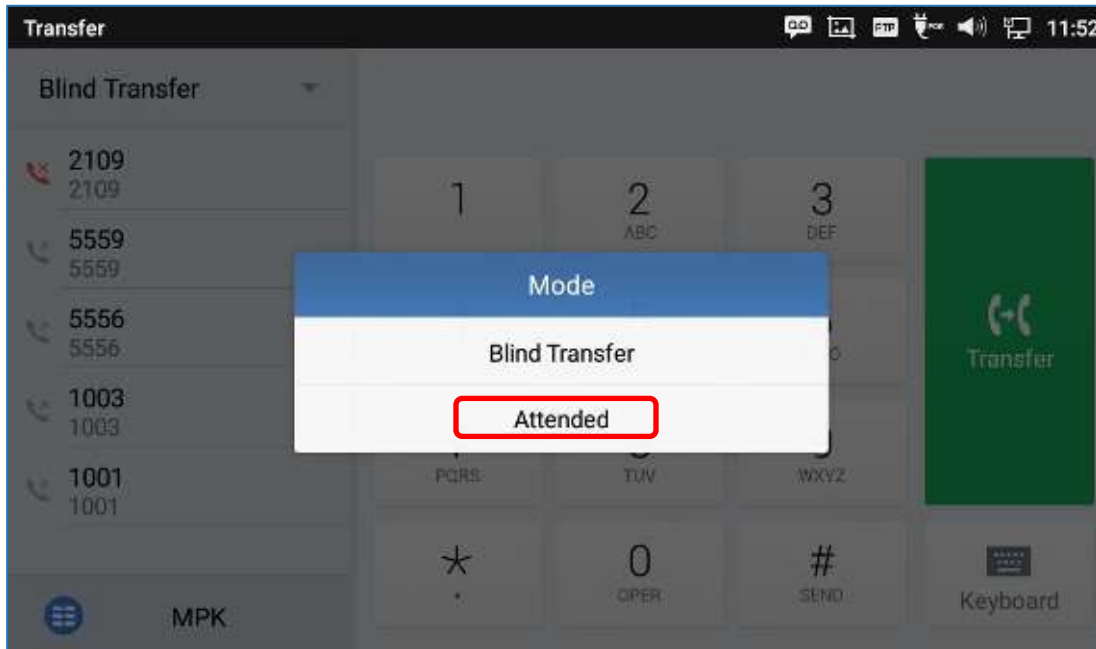

Figure 62: Attended Transfer

3. Enter the transfer target number, and then press the "Send" soft key on the right.
4. Before transfer target answers the call, GXV3370 hears the ringback tone, and the touch screen prompts shown as below. Users could tap on "End" to cancel the transfer, or simply hang up the call to complete call transfer.



Figure 63: Attended Transfer - Transferring

5. After transfer target answers the call, the following screen will be shown up. If the user simply hangs up or taps on "End" soft key, the call will be transferred, and GXV3370 will hang up the call. If the user taps on "Split" soft key to separate the calls, the user will talk to the second established call while the first call is on hold.

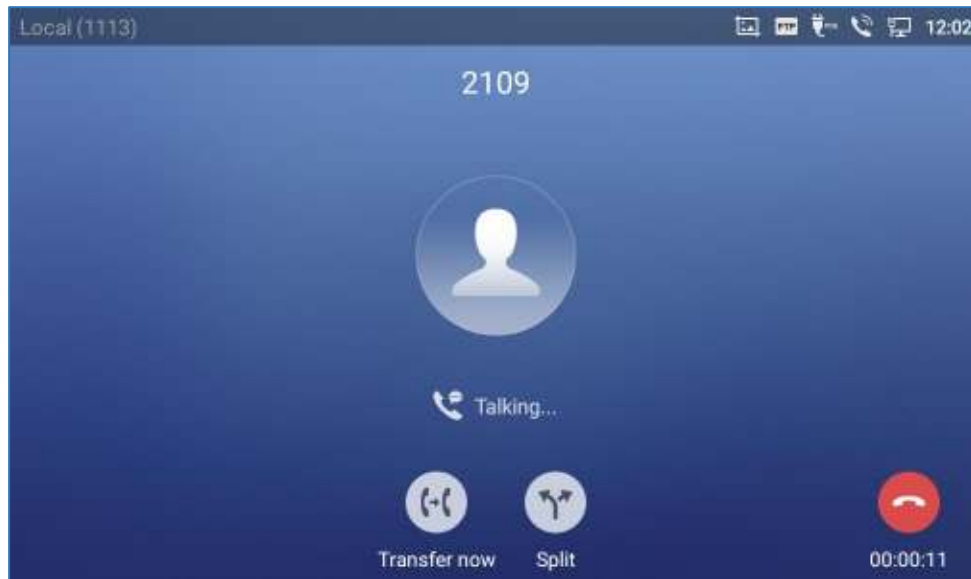



Figure 64: Attended Transfer – Transfer Now - Split

6. Besides attended transfers above, users could also consult the third party first before transferring the call.
7. During the active call, tap More then New Call to make the second call. This will place the current call on hold.
8. The second call establishes after the call is answered.
9. During the active call, tap on **"More"** softkey.
10. Select "Transfer" to bring up transfer screen. The other call on hold will be displayed such as  .
11. Select transfer mode as "Attended" in the transfer mode bar and tap on the call on hold such as  to transfer the call.
12. The call will be transferred, and GXV3370 will hang up the call.

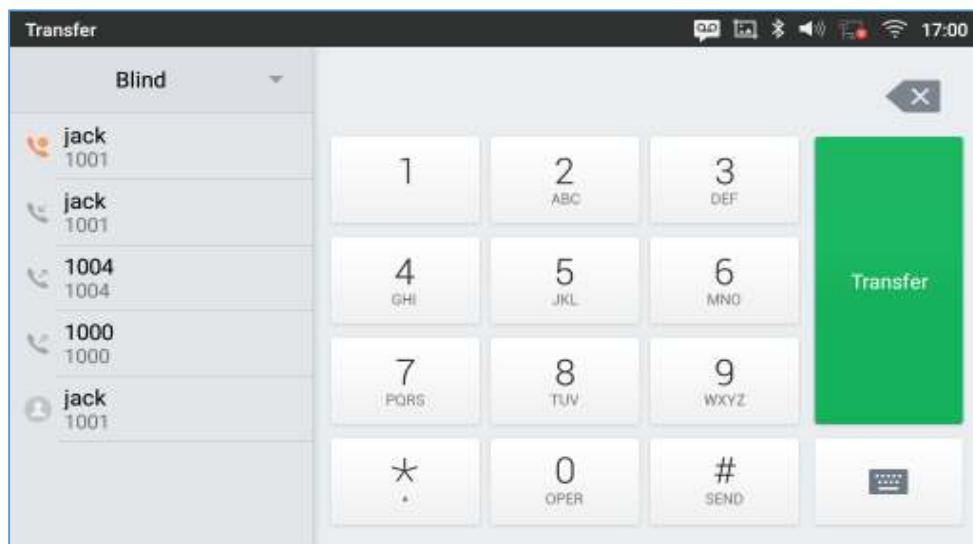

Figure 65: Attended Transfer

Transfer via MPKs

Users have the possibility to transfer calls via Transfer or non-transfer programmable keys (BLF keys)

1. During an active call, press the **Transfer** softkey then press on **MPK**

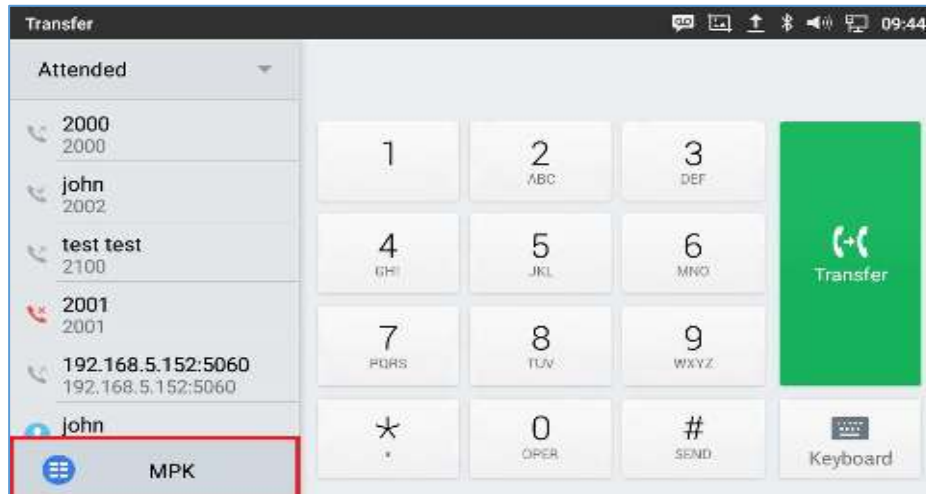

Figure 66: Transfer via MPK

2. Choose the destination to transfer calls to from the MPKs list

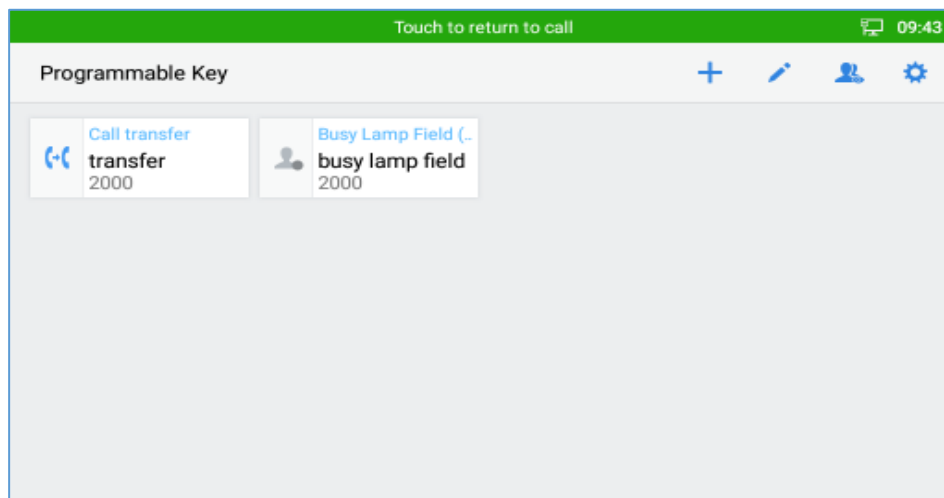



Figure 67: MPK list

Note: The transfer via programmable keys will follow the Default Transfer Mode whether it is Blind Transfer or Attended Transfer specified in WEB UI under Phone Settings -> Call Settings -> Default Transfer Mode.

 **Note:**

- To transfer calls across SIP domains, SIP service providers must support transfer across SIP domains;
 - If users would like to cancel the transfer, press  button to go back to the previous talking screen.
-

7-Way Conference

The GXV3370 supports up to 7-way Audio conferencing and 3-way HD Video conferencing.

Initiate Conference

There are three ways to initiate a conference call.

- **Initiating conference from dial screen**

1. Bring up the dial screen using one of the methods described previously **[Figure 39: GXV3370 Dial Screen]**.
2. Enter the extension number then press on it on the left panel of the screen



Figure 68: Add Conference Members from Dial Screen

3. The extension number will be added to dialing field and users can dial another number



Figure 69: Add Conference Members from Dial Screen 2

4. Using the same method add the other members then press “Audio Call” for an Audio conference or “Video Call” for a video Conference

- **Initiating conference during a phone call**

1. When the phone is on call screen, tap on "Conference" softkey;
2. Enter the third-party number or choose an available number on the left menu from call history or contacts to form a conference of 3. After the call is established, the conference screen is brought up;
3. Tap on  to add another member to the conference;

- **Initiating conference directly using conference soft key**



1. On idle screen, press conference soft key  .
2. Tap on  to add the members of the conference.



Figure 70: GXV3370 Conference Screen

Note: When users press on  to invite another member to the conference, a dial tone will be heard for the user to start dialing the number.

If there are calls on hold, they will show up when adding member to the conference. Users could then tap on the call to add it to the conference directly.



Figure 71: GXV3370 Conference - Add Existing Call to Conference

- Repeat the above steps to add more parties into the conference. The following figure shows a 3-way conference established.



Figure 72: 3-Way Conference Call Established

Note: Every time a conference participant joins or exits the conference when using Full screen, a notification will appear in order to make the GXV3370 host aware of the participant's actions during the conference.

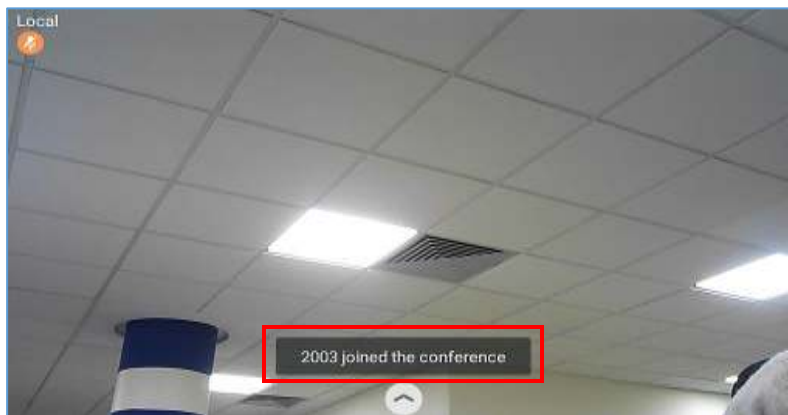

Figure 73: Notification of joining the conference

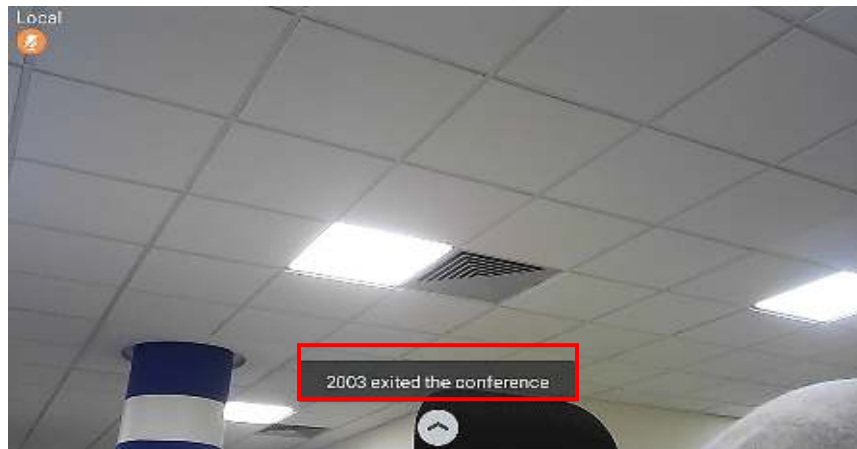



Figure 74: Notification of exiting the conference

Remove Party from Conference

To remove a party from the conference:

1. Tap on the participant icon of the user you want to remove. The below window will show up giving the possibility to Mute enable video Enlarge or hang up.
2. Tap on icon  to remove a party from the conference.

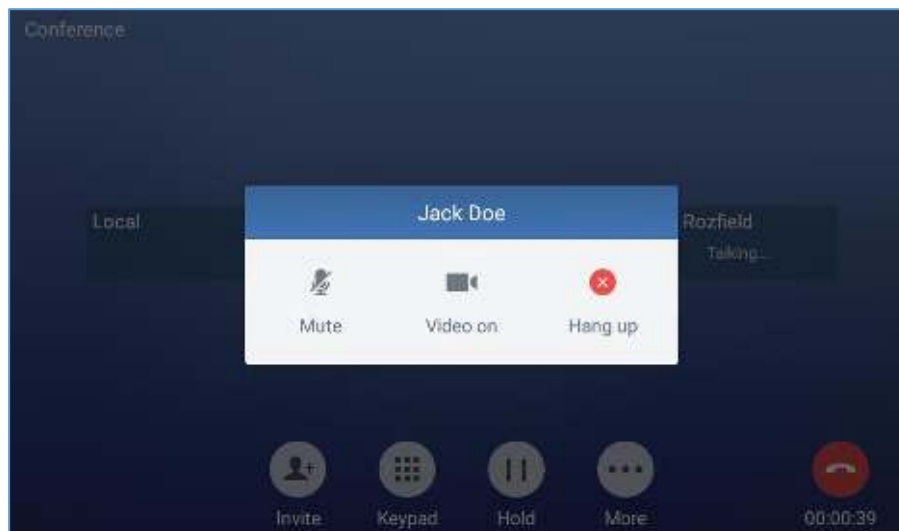



Figure 75: GXV3370 Conference - Remove Party from Conference

End Conference

To end the conference, tap on  to disconnect all the parties from the conference. GXV3370 will hang up the call. If the remote party hangs up the call itself, it will be disconnected from the conference but other parties on GXV3370 will stay in the existed conference.*

Hold and Resume Conference

During the conference, users could tap on More softkey then tap on Hold to hold the conference at any time. To resume the call, tap on UnHold.

Auto Conference Mode

The GXV3370 also supports "Auto Conference" which allows users to establish conference call in a quick and easy way, instead of adding the other parties one by one. To enable Auto Conference feature, go to web GUI→**Phone Settings**→**Call Settings**→**Call Features** and set "**Auto Conference**" to "Yes".

To establish call with auto conference when there are 1 or more calls on the GXV3370, simply tap on "More" softkey and select "Conf". All the calls on GXV3370 will be brought into the conference.

Multicast Paging

Multicast paging is an approach to let different SIP users to listen to a page from a common multicast IP address. In multicast page call, one way audio will setup from sender to listeners, but the listeners cannot talk to each other. The sender and listeners must be located within the same LAN.

Sender multicast page configurations are under Web UI Settings → Applications → Programmable Key → BLF → Press on Add.

1. Set the key Mode to Multicast Paging in dropdown list.
2. Enter the multicast paging description in Display Name field.
3. Enter multicast paging address and port in URL field. The range of multicast page address is 224.0.0.0 to 239.255.255.255 with a port not in use by phone.

To receive multicast page, the GXV3370 must be well configured to listen to the right address and port. The configurations are under Phone Settings->Multicast Paging → Multicast Listening. There are 10 listening address supported. After multicast page listening well configured, please reboot the phone to let the settings take effect.

Multicast Listening Switch

Users can enable/Disable multicast listening feature from Multicast listening widget. When Multicast listening widget is set to ON; The phone will be listening to Multicast paging calls.



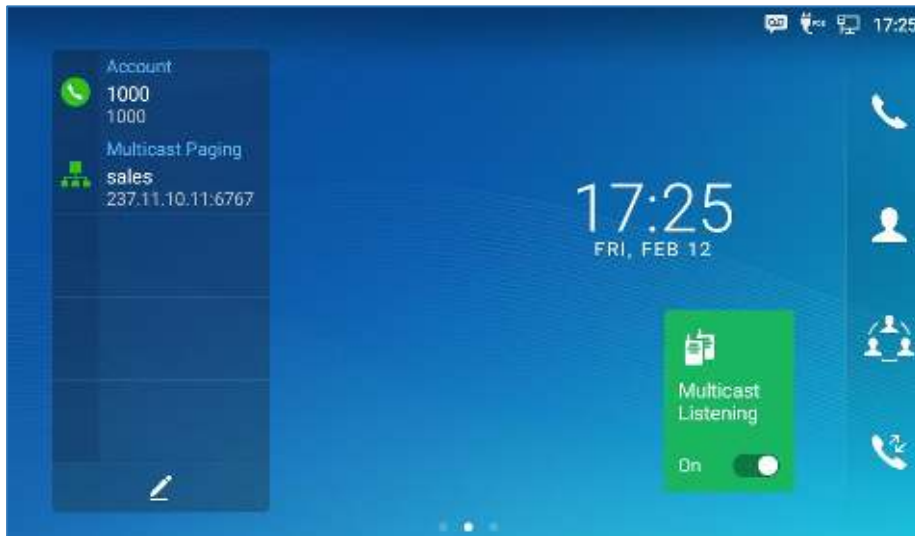

Figure 76: Multicast Listening widget – On

UCM Conference

Participate in UCM Conference Room

Users could dial the UCM conference room extension to join the conference. If password is required, enter the password to join the conference as a normal user, or enter the admin password to join the conference as administrator.



Figure 77 : Join UCM Conference Room

CCM (Conference Call Menu)

During a UCM conference, Administrators can tap on the UCM conf menu



Figure 78: UCM conference Menu

Administrators could view/invite members, bridge conference, remove bridge, mute, unmute and lock the conference



Figure 79 : Conference Menu Options

Conference Call Operations

- Click on  to list all the users currently in the conference

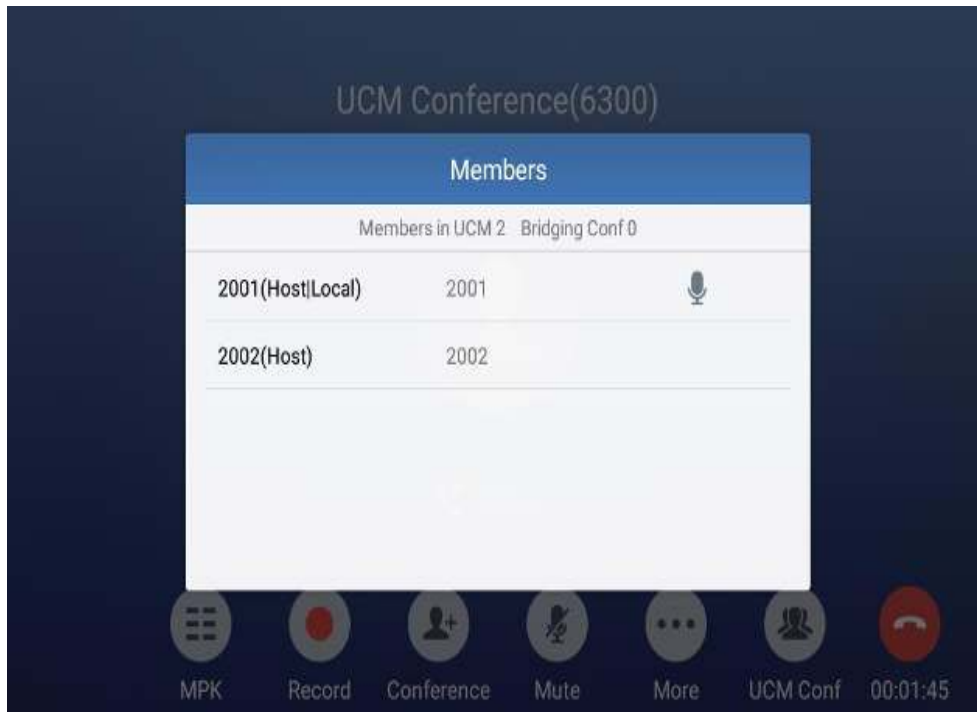



Figure 80: Conference's members list

- Click on  to invite other users into the conference room.

Users can send invitations to others to participate in the conference by pressing on the **Invite** option and then enter the member number an invitation will be sent to that number to join the conference room.

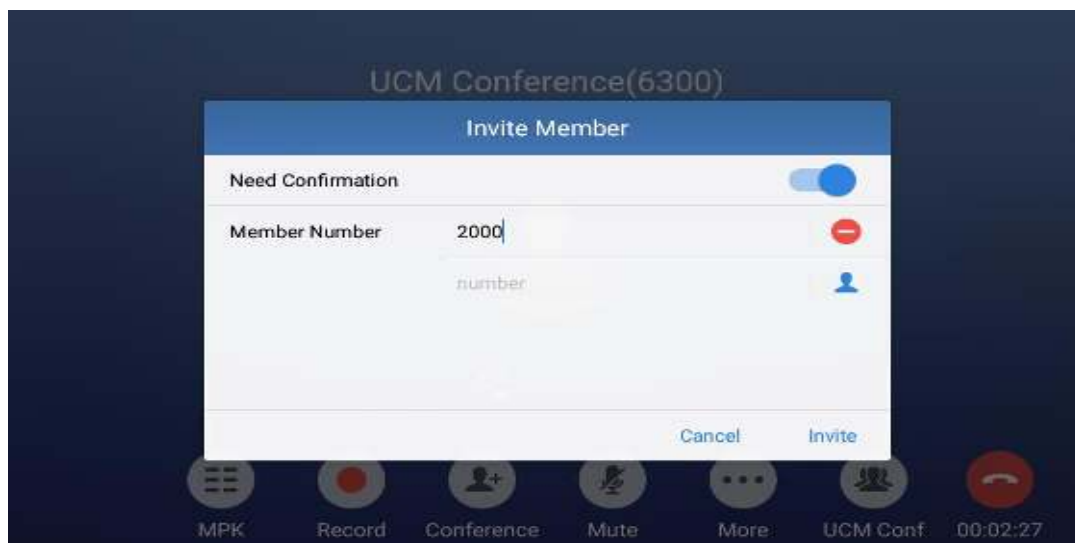



Figure 81: Invite a member

- Click on  to bridge another conference, Enter the conference number and password and Bridge request will be sent.

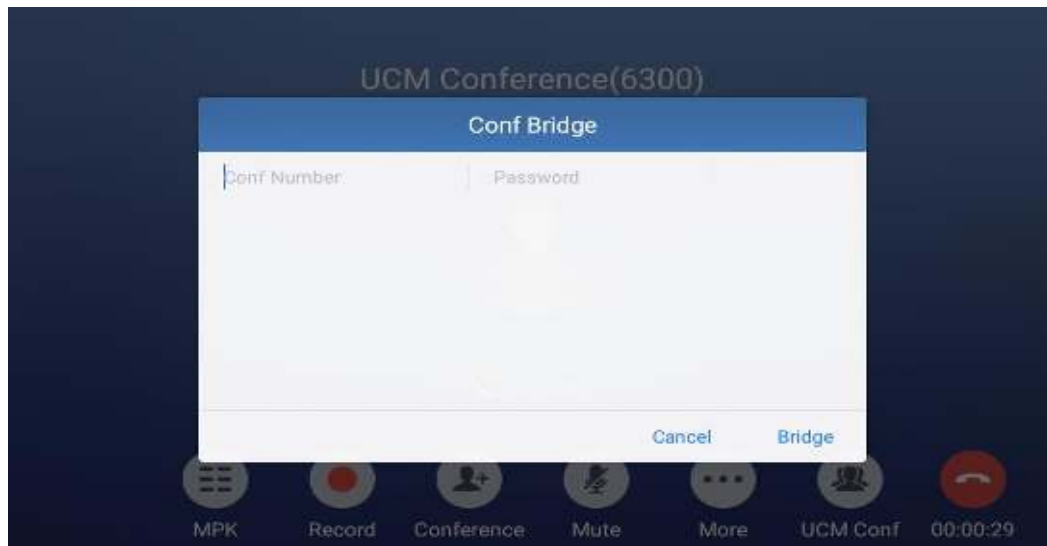





Figure 82: Conference Bridge

- Click on  to remove Conf Bridging.
- Click on  to Mute conference.
- Click on  to Unmute.
- Click on  to lock this conference room so that other users cannot join it anymore.

CEI (Conference Event Indicator)

If CEI is enabled, Events like members joining/Leaving the conference, Invitation sent, Mute/Unmute ... will be displayed in the call screen as the examples shown below:

- Member joined



Figure 83: Member joined conference Event

- Member left



Figure 84 : Member Left the conference room Event

- Member invitation sent



Figure 85: Invitation sent Event Notification

Missed Call

When there is a missed call, the LCD will show missed call dialog on the idle screen.

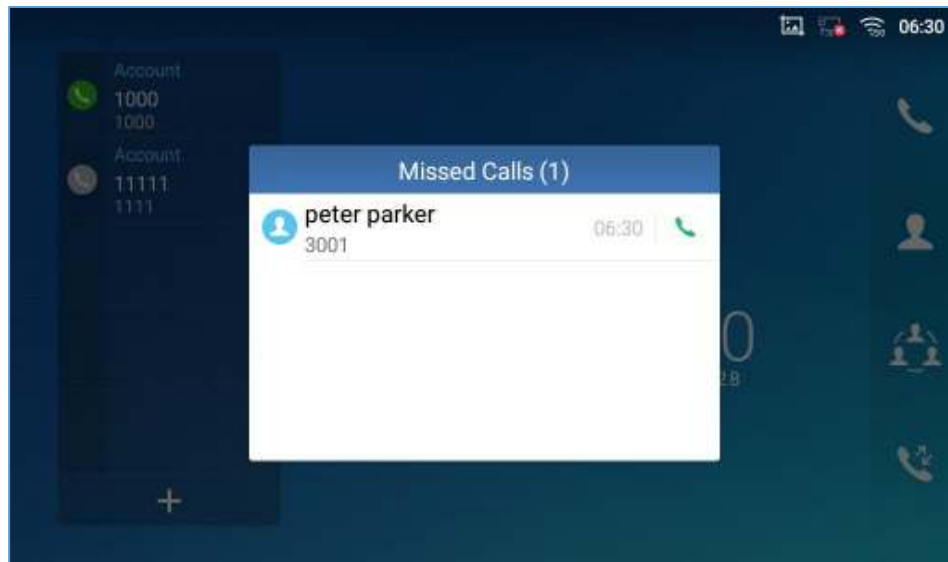





Figure 86: Missed Call Screen

Users can tap on the missed call entry to access the missed call log. To close the missed call screen and return to the idle screen, tap on  on the upper right of the dialog.

DND (Do Not Disturb)

When DND is on, the incoming calls to the GXV3370 will be blocked for all registered accounts with a reminder ring produced. To turn on/off DND:

1. Touch and drag the status bar down on the GXV3370 idle screen.
2. Tap on the DND icon  to turn it on. The status bar shows icon  indicating DND is on.
3. Tap on the DND icon  to turn it off.

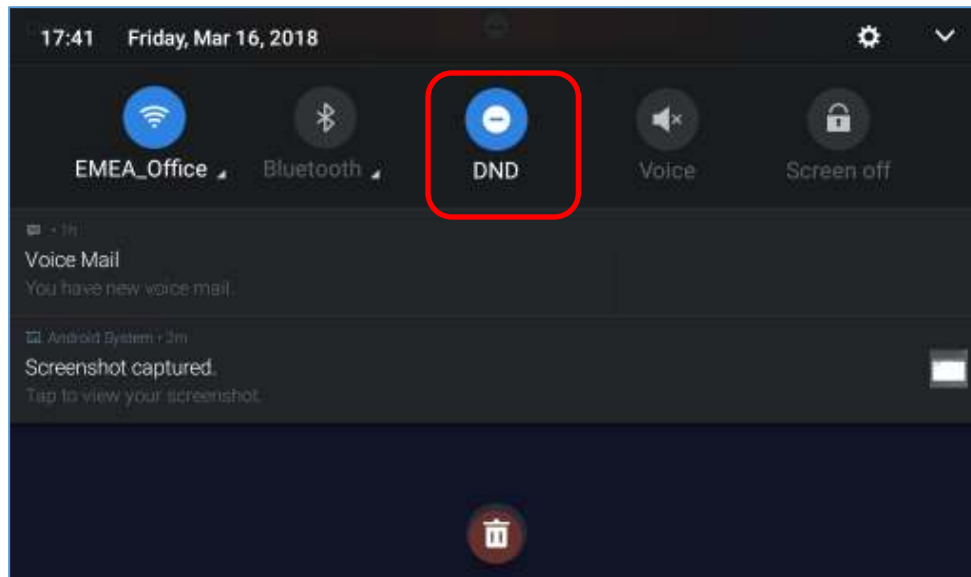



Figure 87: Enable/Disable DND

 **Note:**

- When the phone is in an active call, turning on/off DND will not affect the current active call. It will take effect starting from the next incoming call.

Voicemail/Message Waiting Indication

When there is a new voicemail, the Message Waiting Indication (MWI) LED icon will blink in red on the upper right corner of the GXV3370 and  will show up in the status bar.

To retrieve the voicemail:

1. Tap on the Message icon  from the applications section to bring up voicemail screen. All the registered accounts and the number of voicemails is displayed there.
2. Tap on the account to dial into the voicemail box. Then follow the Interactive Voice Response (IVR) for the message retrieval process.



Figure 88: Retrieve Voicemail

For each account, the Voicemail User ID can be set up under web GUI → **Account X** → **Call Settings**: "Voice Mail Access Number". This is the number that will be dialed out to access voicemail message when tapping on the account in Voice Mail screen.

Call Forward

Call forward feature can be set up from GXV3370 LCD or web GUI.

- **From LCD**

Go to onscreen Menu → **Settings** → **Features** → Call Forward. Select account name and tap on **Call Forwarding** to activate the feature. Then the list of options will be available. Select the option Call Forward Mode to configure the call forward type (Unconditional, Time Based, Others) and then enter necessary number in the fields.

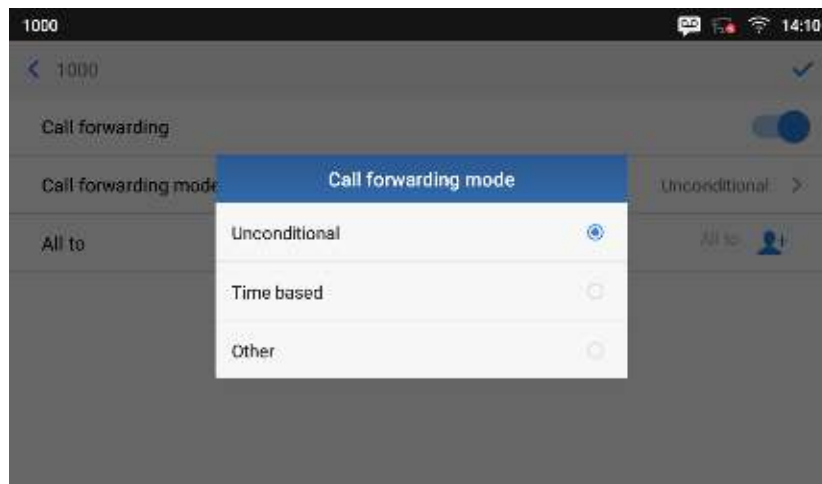
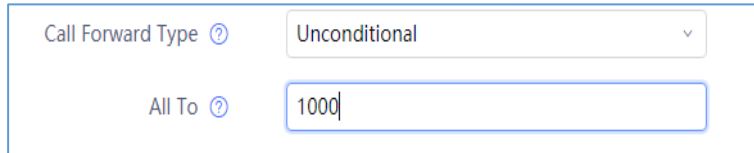

Figure 89: Unconditional Call Forward

- **From Web GUI**

Log in GXV3370 web GUI and go to **Account page** → **Call Settings**. By default, Call Forward feature is set to "None". The Call Forward feature options are:

- **Unconditional Forward:** All the incoming calls will be forwarded to the number set up in "All To" field.



Call Forward Type ? Unconditional

All To ? 1000

Figure 90: Call Forward – Unconditional

- **Time Based Forward:** All the incoming calls will be forwarded to the number as schedule in the time period. During the setup time, the call will be forwarded to the number in "In Time Forward To:" field. Other period the call will be forwarded to the number in "Out Time Forward To:" field.

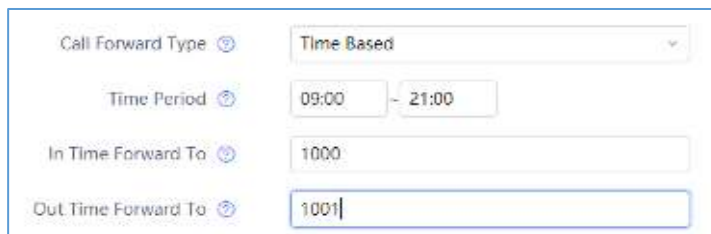

Call Forward Type ? Time Based

Time Period ? 09:00 ~ 21:00

In Time Forward To ? 1000

Out Time Forward To ? 1001

Figure 91: Call Forward - Time Based

- **Call Forward on Busy / Call Forward No Answer / Call Forward on DND:** The incoming call will be forwarded when the GXV3370 is busy or no answer after certain interval "Delayed Call Forward Wait Time (s)", or if the phone is on DND mode then the call will be forwarded to the configured destination number.

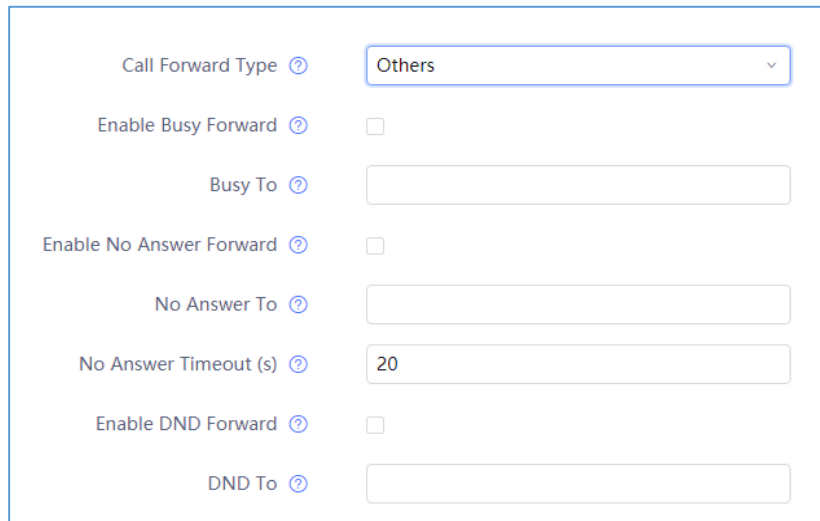

Call Forward Type ? Others

Enable Busy Forward ?

Busy To ?

Enable No Answer Forward ?

No Answer To ?

No Answer Timeout (s) ? 20

Enable DND Forward ?

DND To ?

Figure 92: Call Forward - Busy/No Answer/DND

Call Features

The GXV3370 supports traditional and advanced telephony features including caller ID, caller ID with caller Name, call waiting, call forward etc. Before using the following feature codes, please make sure "Enable Call Features" option is set to "Yes" under web GUI → **Account** page → **Call Settings**.

Table 10: GXV3370 Feature Code

*01	<p>Use Preferred Codec (per call)</p> <ul style="list-style-type: none"> • Dial *01 followed by the preferred codec code and the phone number. • The phone will try to use this codec during the call. • Codec code: PCMU: 7110 PCMA: 7111 G726-32: 72632 G722: 722 iLBC: 7201 <p>For example, if the user would like to use PCMA as the preferred codec to call phone number 334455, enter *017111334455.</p>
*02	<p>Force Codec (per call)</p> <ul style="list-style-type: none"> • Dial *02 followed by the preferred codec code and the phone number. • The phone will be forced to use this codec during the call. • Codec code: PCMU: 7110 PCMA: 7111 G726-32: 72632 G722: 722 iLBC: 7201 <p>For example, if the user would like to use PCMA to call phone number 334455, enter *027111334455.</p>
*30	<p>Block Caller ID (for all subsequent calls)</p> <ul style="list-style-type: none"> • Dial *30.
*31	<p>Send Caller ID (for all subsequent calls)</p> <ul style="list-style-type: none"> • Dial *31.
*50	<p>Disable Call Waiting</p> <ul style="list-style-type: none"> • Dial *50.



*51	Enable Call Waiting <ul style="list-style-type: none"> Dial *51.
*67	Block Caller ID (per call) <ul style="list-style-type: none"> Dial *67 followed by the phone number.
*82	Send Caller ID (per call) <ul style="list-style-type: none"> Dial *82 followed by the phone number.
*70	Disable Call Waiting (per Call) <ul style="list-style-type: none"> Dial *70 followed by the phone number.
*71	Enable Call Waiting (per Call) <ul style="list-style-type: none"> Dial *71 followed by the phone number.
*72	Unconditional Call Forward. To set up unconditional call forward: <ul style="list-style-type: none"> Dial *72 followed by the phone number to forward the call.
*73	Cancel Unconditional Call Forward. To cancel the unconditional call forward: <ul style="list-style-type: none"> Dial *73.
*74	Paging Call <ul style="list-style-type: none"> Dial *74 followed by the phone number to send the paging call.
*83	Force Audio Calling (per call) <ul style="list-style-type: none"> Dial *83 followed by the phone number to send the audio call.
*84	Force Video Calling (per call) <ul style="list-style-type: none"> Dial *84 followed by the phone number to send the video call.
*90	Busy Call Forward. To set up busy call forward: <ul style="list-style-type: none"> Dial *90 followed by the phone number to forward the call.
*91	Cancel Busy Call Forward. To cancel the busy, call forward: <ul style="list-style-type: none"> Dial *91.
*92	Delayed Call Forward. To set up delayed call forward: <ul style="list-style-type: none"> Dial *92 followed by the number to forward the call. The default timeout before the call is forwarded is 20 seconds.
*93	Cancel Delayed Call Forward. To cancel the delayed call forward: <ul style="list-style-type: none"> Dial *93.

CONTACT

The GXV3370 supports local, LDAP and BroadWorks XSI Contacts.

To access GXV3370 contacts, on the phone's idle screen, tap on icon  on the right panel. The following figure shows Contacts on the GXV3370.

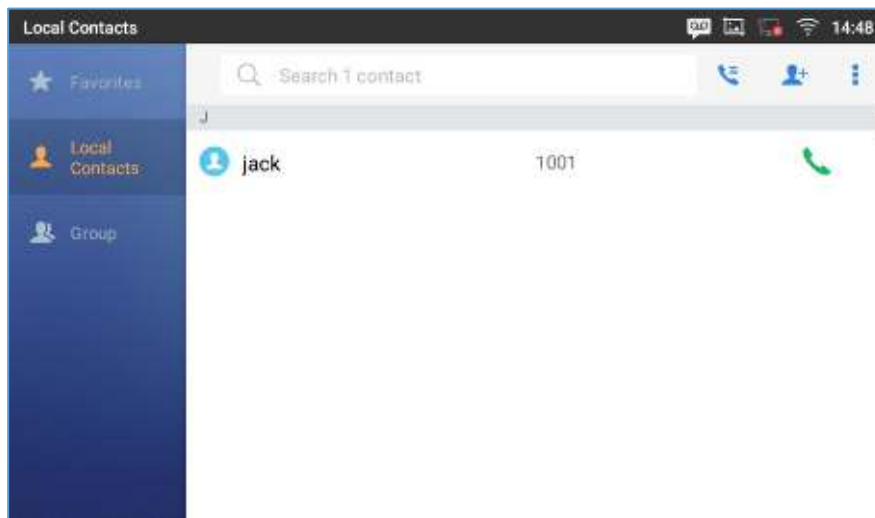

Figure 93: GXV3370 Contacts

The BS Contacts is the BroadWorks XSI Contacts. It needs to be configured with the remote BroadWorks server to enable this feature.

Local Contacts

The local contacts can save up to 1000 entries. Users can manage contacts by adding, deleting, and modifying single contacts, downloading contacts from HTTP/TFTP server, importing contacts from external storage, and exporting contacts to external storage.

Note: A reminder prompt is shown on the GXV3370 LCD screen when adding a number of contacts more than the allowed one (when importing contacts for instance).

Add Single Contacts

1. On the Local Contacts menu Tap on  to bring up "Create Contact" dialog to manually add a new contact. See [Figure 94: GXV3370 Contacts - Add New Contact].
2. Type First name, Last name, Phone number and other information for the new contacts. Please make sure the account number field is selected so the GXV3370 will use this account to dial out the new contact. The account number field is located on the left of the "Phone" field as highlighted below.

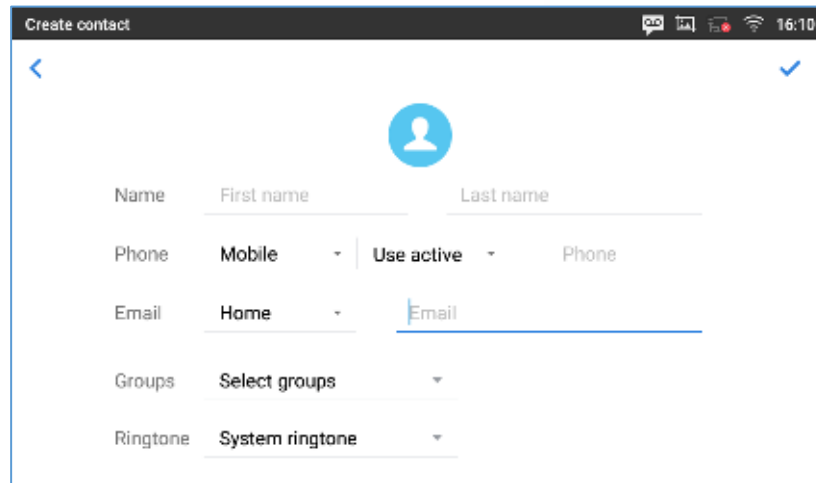

Figure 94: GXV3370 Contacts - Add New Contact

Note: When typing a number using dial pad, “Add to contacts” button will appear as displayed on following picture, to add a new entry to your contacts list if the input number does not match any entry in your contacts.



Figure 95: Add to Contacts from Dial Pad

Import/Export Contacts

If the users have the GXV3370 phonebook file saved in local storage or external storage device that has been plugged into the GXV3370, the phonebook file can be directly imported to the Contacts. There are two different formats supported for the phonebook file: "vCard", and "xml". Users could manually create contacts first and export the phonebook file in vCard or xml format to take a look on the phonebook file.

To Import Contacts:

1. Open Contacts.
2. Tap on More  on the upper right corner of the Contacts screen.
3. Select "Import contacts" to bring up the dialog below.



4. Fill in the import options and scroll down to the bottom of the screen.
5. Tap on "Select file" to import phonebook file from the directory in internal or external storage device.

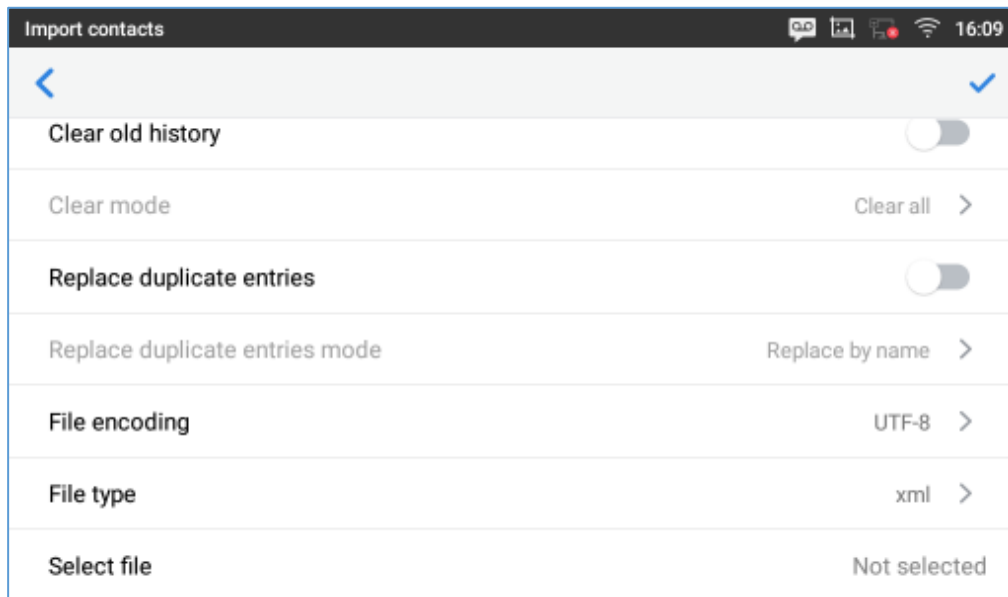

Figure 96: GXV3370 Contacts - Import Contacts

To Export Contacts:

1. Open Contacts.
2. Tap on More  on the upper right corner of the Contacts screen.
3. Select "Export Contacts " to bring up dialog below.
4. Select the file encoding and file type for the exported phonebook file. By default, the GXV3370 is using "UTF-8" as the encoding method.
5. Tap on "Choose Directory" and select the directory where the phonebook file will be exported to.





Figure 97: GXV3370 Contacts - Export Contacts

Download Contacts

The GXV3370 supports downloading XML phonebook from a remote HTTP/TFTP/HTTPS server to local Contacts. When downloading the phonebook, the GXV3370 sends request to the HTTP/TFTP/HTTPS server looking for file **phonebook.xml**. For more details about GXV3370 phonebook, please refer to the following link:

http://www.grandstream.com/sites/default/files/Resources/gxv3275_xml_phonebook_guide_1.pdf

To download phonebook:

1. Make sure the GXV3370 can connect to the HTTP/TFTP/HTTPS server and the phonebook.xml file in correct format is downloadable from the HTTP/TFTP/HTTPS server.
2. Open Contacts.
3. Tap on More  on the upper right corner of the Contacts screen.
4. Select "Download Contacts" to bring up the dialog below.
5. Fill in the necessary options and then tap on  in the upper right corner of the screen. The GXV3370 will send out request to the configured HTTP/TFTP/HTTPS server.

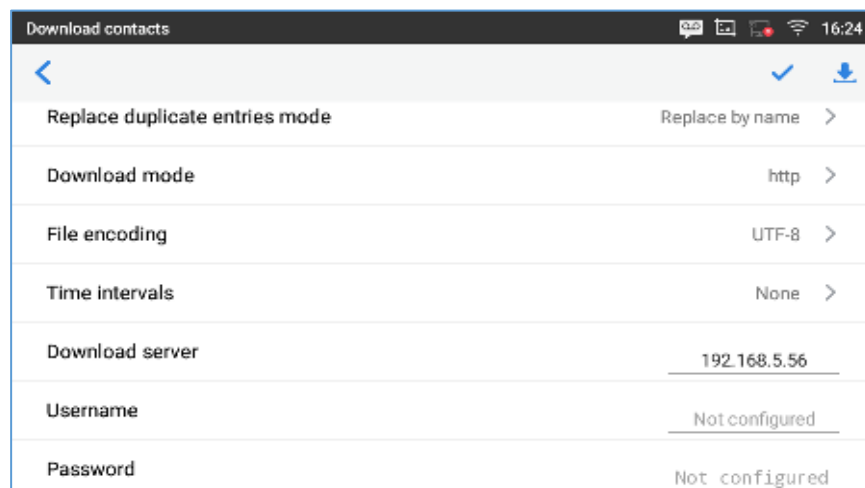



Figure 98: GXV3370 Contacts - Download Contacts

Search Contacts

1. Open Contacts.
2. Tap on the search field .
3. Enter a contact's name or a number to search. The search result will be automatically updated and displayed when entering the key words.

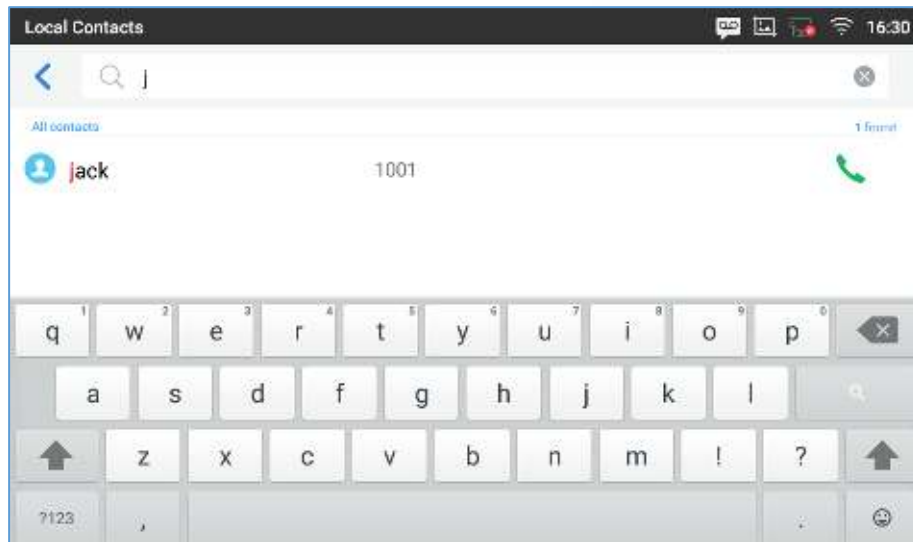



Figure 99: GXV3370 Contacts - Search Contacts

Use Contacts

Once the contacts are added, users could navigate in the contacts list  to make a call and manage the contacts furthermore.

Make a Call to Contacts

Scroll up/down to find the contact in the list and tap on  to call this contact.

Select Contacts

1. Scroll up/down to find the contact in the list.
2. Touch and press on the contact for about 2 seconds to show more options such as Delete contact, add to blacklist etc.
3. To select a batch of contacts at the same time, press More  on the upper right corner of the contacts screen and select Batch operation, Tap on the checkbox for the contacts to be selected.

 indicates the contact is selected.

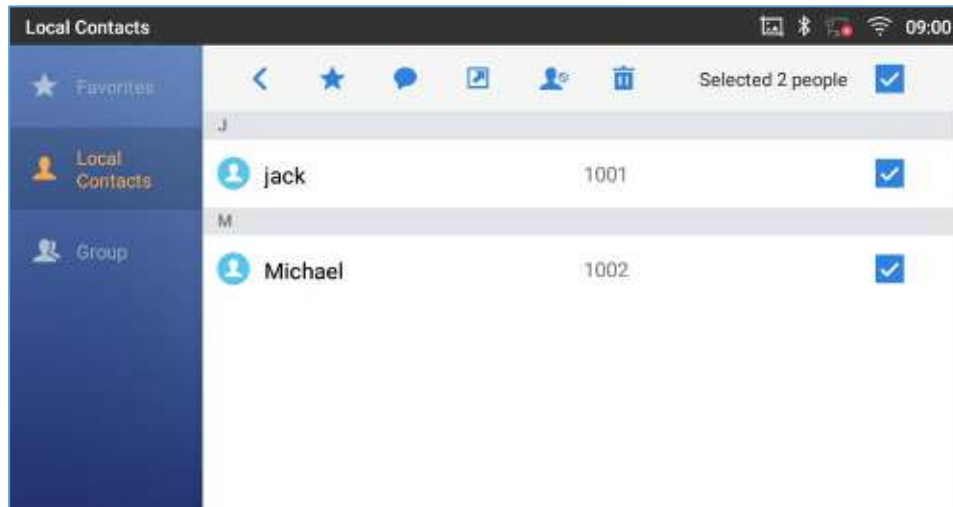





Figure 100: GXV3370 Contacts - Select Contacts

Add Contacts to Favorites

1. Select the contact/contacts to be added as described in [\[Select Contacts\]](#).
2. Then tap on  to add the contacts selected to Favorites

There are two other methods to add contacts to favorites.

- Directly pressing on the contact and tap on  to add the contact to favorite.
- Tapping on “Favorites” on the Contacts screen to navigate to favorites category and tap on  to select the contacts to be added to favorites then tap on .

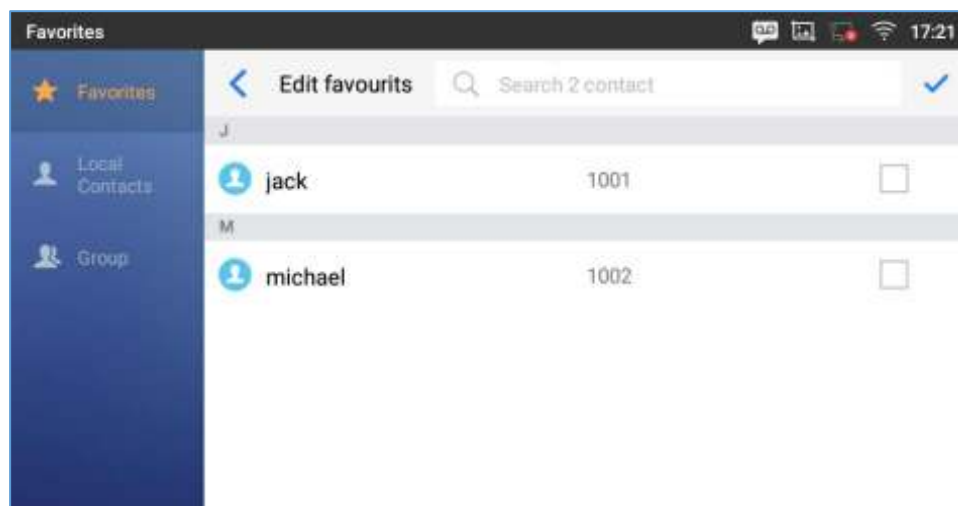



Figure 101: Add Contacts to Favorites

Edit Contacts

1. Tap on a contact from the contacts list
2. Tap on  to edit the contact.

Send Contacts to Desktop Shortcut

1. Long press on the contact
2. Tap on Send to Desktop from the menu.

Share Contacts Via Bluetooth

Users can share a single contact or a batch of contacts. Refer to the following steps to do so:

- **Sharing a single contact:**

1. Long press on the contact
2. Select "Send" from the menu then choose the Bluetooth device that you want to share the contact with.

- **Sharing a batch of contacts:**

1. Select the contacts as described in [**Select Contacts**].
2. Press on  to share the selected contacts via Bluetooth

Add Contacts to Blacklist

Users can add a single contact or a batch of contacts to the blacklist. Refer to the following steps to do so:

- **Add a single contact to blacklist:**



1. Long press on the contact
2. Select "Add to Blacklist" from the menu.

- **Add a batch of contacts to blacklist:**

1. Select contacts as described in [**Select Contacts**].
2. Press on  to add the selected contacts to the blacklist



Add Group

Open Contacts and tap on  to access "Group". To add a new group, tap on  and name the new group.

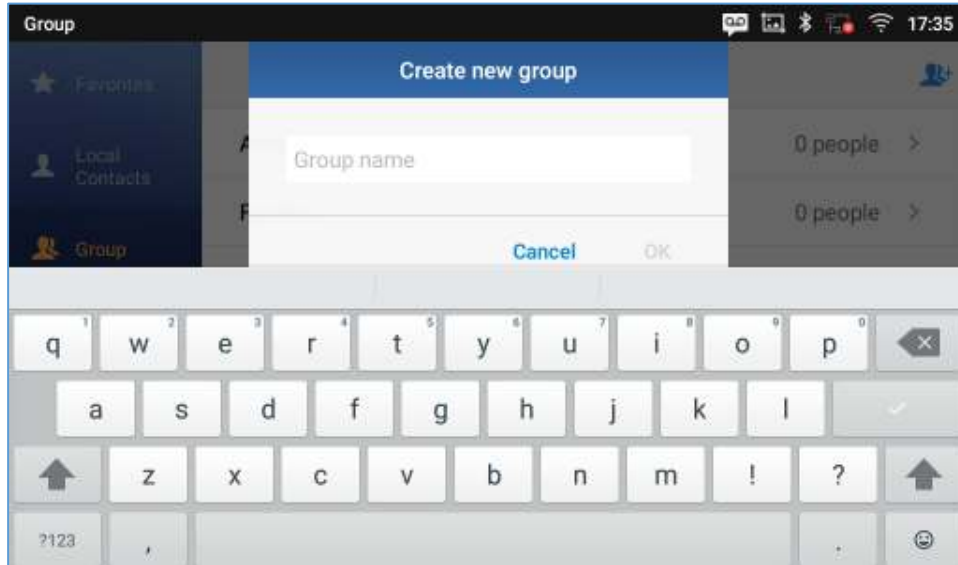



Figure 102: GXV3370 Contacts - Add New Group

Add contacts to Group

To add contacts to a group, tap on the group then tap on , check the contacts to be added to the group and press .

Note:

- Users could also select a group for the contact when adding or editing the contact.
 - Ringtone can be assigned in group as well as single contact. If the group has ringtone set to "Custom Ringtone", this ring tone has the highest priority when there is an incoming call to the contact.
-

Contacts Storage Status

The GXV3370 default maximum contacts storage is up to 1000. To check contact storage status, tap on

More on the upper right corner of the contacts screen  to bring up contacts options, scroll down and select "Storage Status".

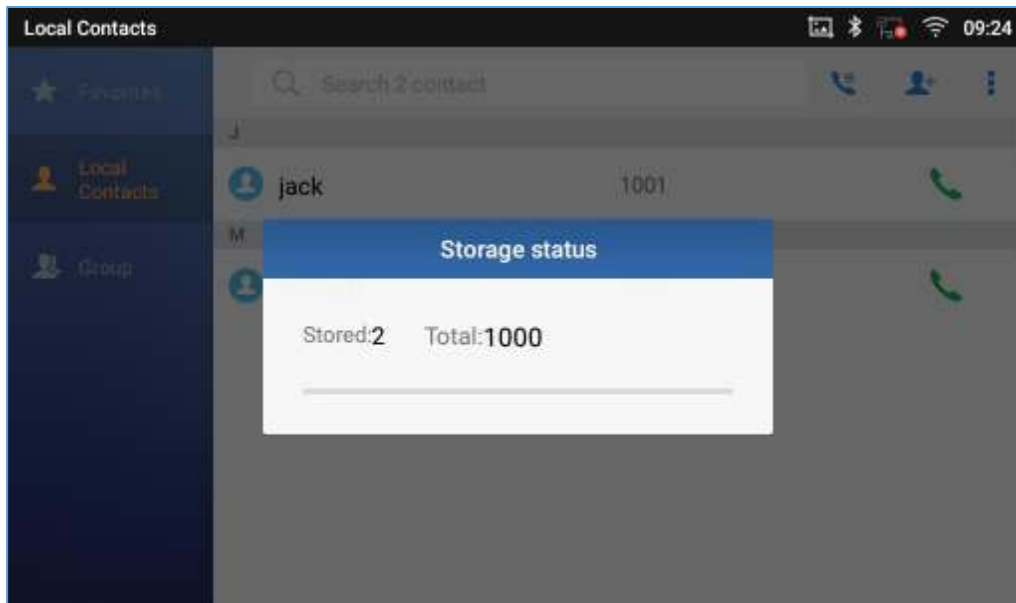



Figure 103: GXV3370 Contacts - Storage Status

Note:

Users could increase the number of maximum contacts storage to more than 1000 contacts on GXV3370. Users may access the phone through SSH and change the P value P1688 to another number (≤ 10000) to increase the default contacts storage. In this case, if users increase this default P value, the phone resource will be cost, and the phone performance will be slower.

GXV3370 SETTINGS

Users could access the GXV3370 Settings by tapping on the icon  .

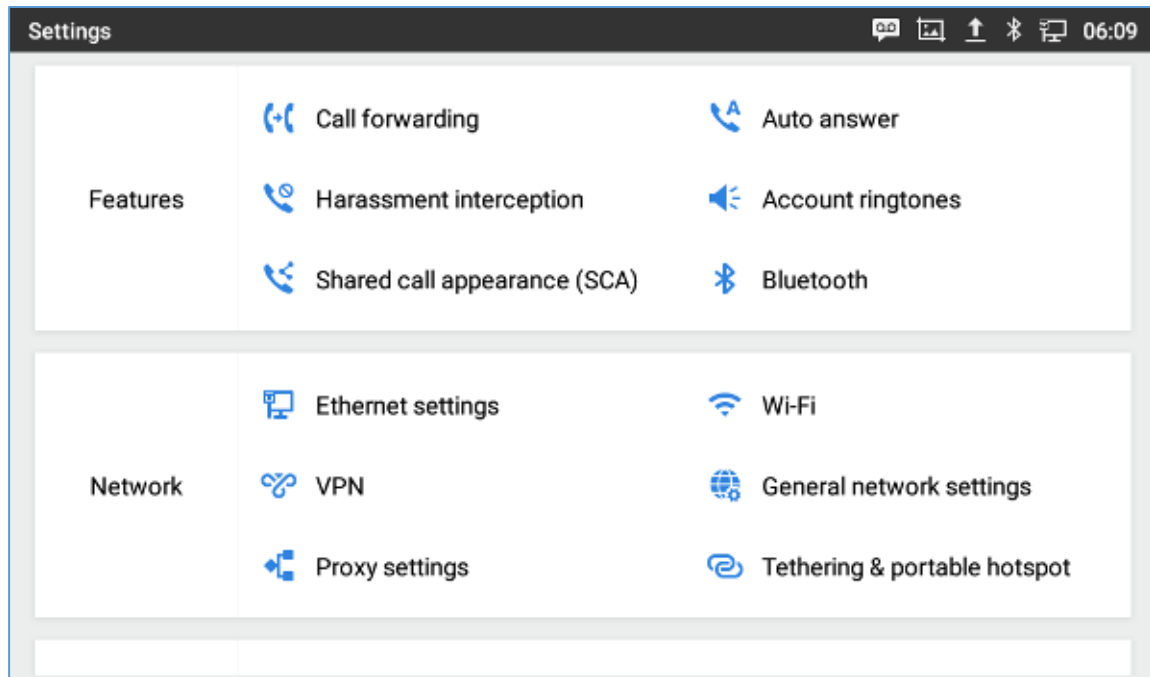

Figure 104: GXV3370 Settings

Users can find all the features and options that require configuration. Please, refer to the following table to have a clear idea about all the options available under this section:

Features	<ul style="list-style-type: none"> • Call forwarding • Harassment Interception • Shared Call Appearance (SCA) • Auto Answer • Account Ringtones • Bluetooth
Network	<ul style="list-style-type: none"> • Ethernet Settings • VPN • Proxy Settings • Wi-Fi • General Network Settings • Tethering & Portable Hotspot
Basic	<ul style="list-style-type: none"> • Sound • Language & Keyboard • Display • Date & Time

	<ul style="list-style-type: none">• Security Settings• Peripherals• Accounts• Power Information• Reboot the phone
Apps	<ul style="list-style-type: none">• Application Management• Default Application• Notification Center
Advanced	<ul style="list-style-type: none">• Account Settings• System Update• Syslog• System Security
Status	<ul style="list-style-type: none">• Account Status• Network Status• System Info• Storage Status

HARASSMENT INTERCEPTION

The GXV3370 has blacklist support for users to manage incoming calls. To access blacklist, tap on “Settings” icon then under “Features”, access “Harassment Interception”.

Blocked Contacts

The blocked Contacts are the contacts that were added to the blacklist, the GXV3370 will block any calls coming from these contacts. To show the blocked contacts tap on Blacklist from the Harassment Interception page.



Figure 105: List of blocked contacts

Block History

To show the history of blocked contacts/numbers, tap on call history from home screen then on “Blocked”.



Figure 106: Block History

Delete Block History

1. In the block history, tap on the recycle bin icon 
2. Confirm the deletion of the complete blocking record by pressing “OK”

Edit Blacklist

Tap on Blacklist under the Harassment Interception Menu to show the blacklisted contacts

- **Add number to blacklist**

1. Tap on  to start adding new entry to the blacklist. The blacklist can be added manually, from contacts, or from call history.

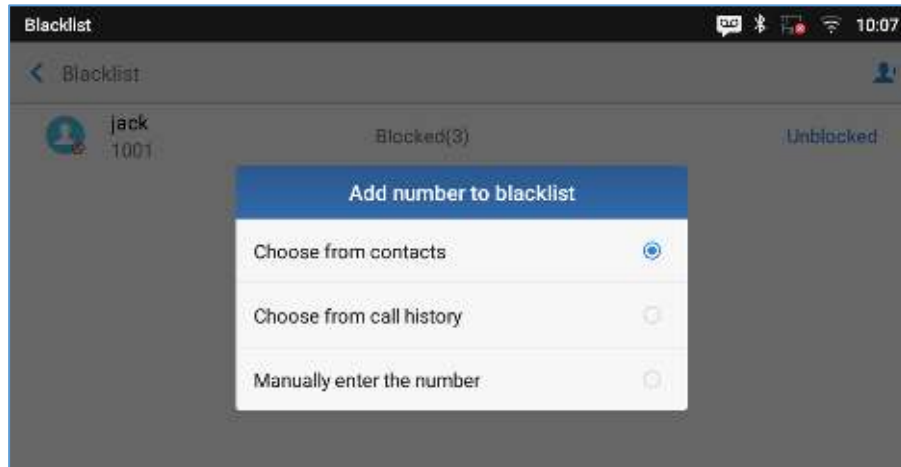

Figure 107: GXV3370 Blacklist - Add Number to Blacklist

2. The following figure shows manually adding number to blacklist. Once **Manually add** option is selected, a window will be prompted for users to enter the phone number in the first field and name/note in the second field (optional). Tap on **OK** to finish the adding operation.

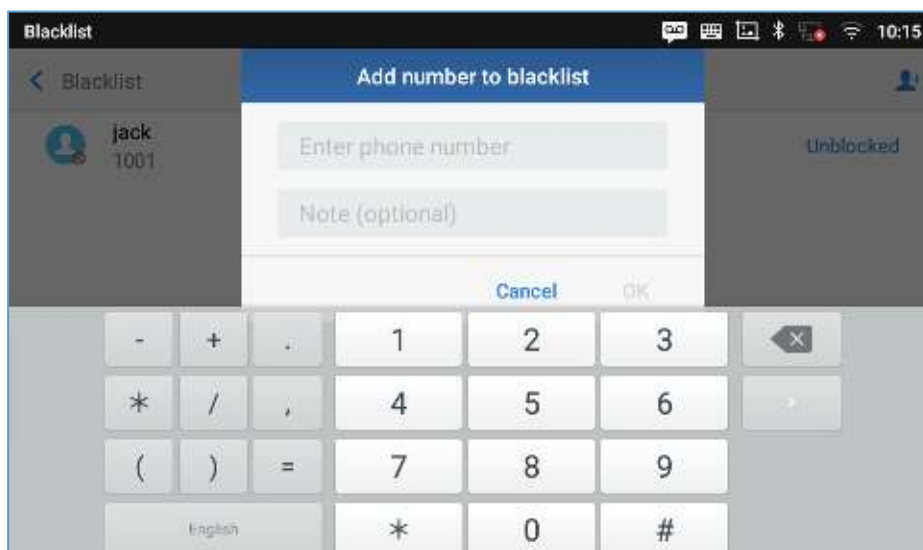

Figure 108: Manually Add Number to Blacklist

- **Edit Blacklist**

1. In the blacklist, touch and press the entry for about 2 seconds a prompt allowing changing the name/note is displayed
2. Change the name/note.
3. Tap on OK once done.

- **Delete Blacklist**

Users can Delete/unblock contacts from the blacklist using two methods:

1. From the blacklist menu press on “Unblocked” to no longer block the calls from coming from this contact.
2. From the contacts menu, long press on the contact and press “Remove from Blacklist”.

Intercept Anonymous calls

The GXV3370 gives the possibility to intercept anonymous calls for each account registered:

1. Enter the harassment Interception Menu.
2. Check **Intercept Anonymous Calls** as shown on the figure below.
3. Check the account to apply the interception.

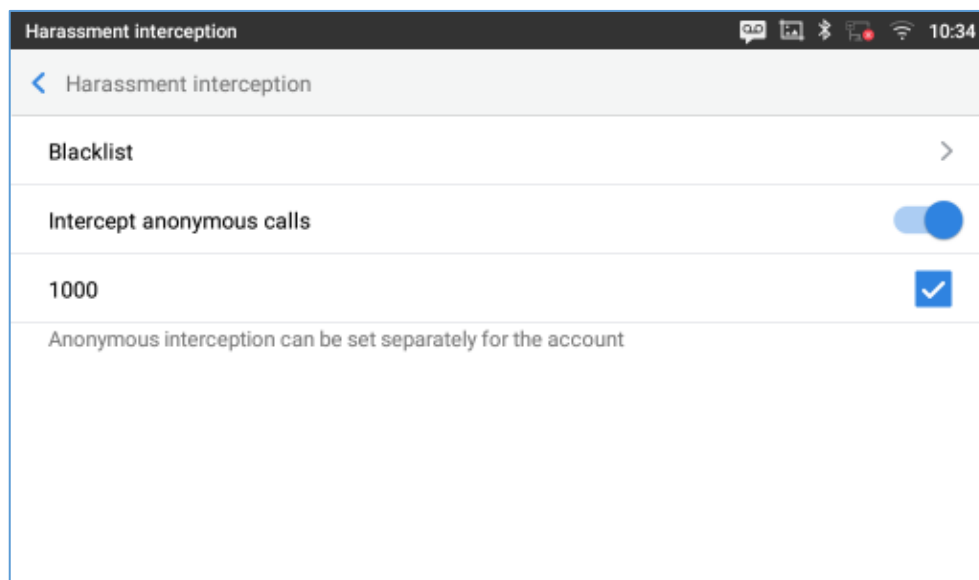

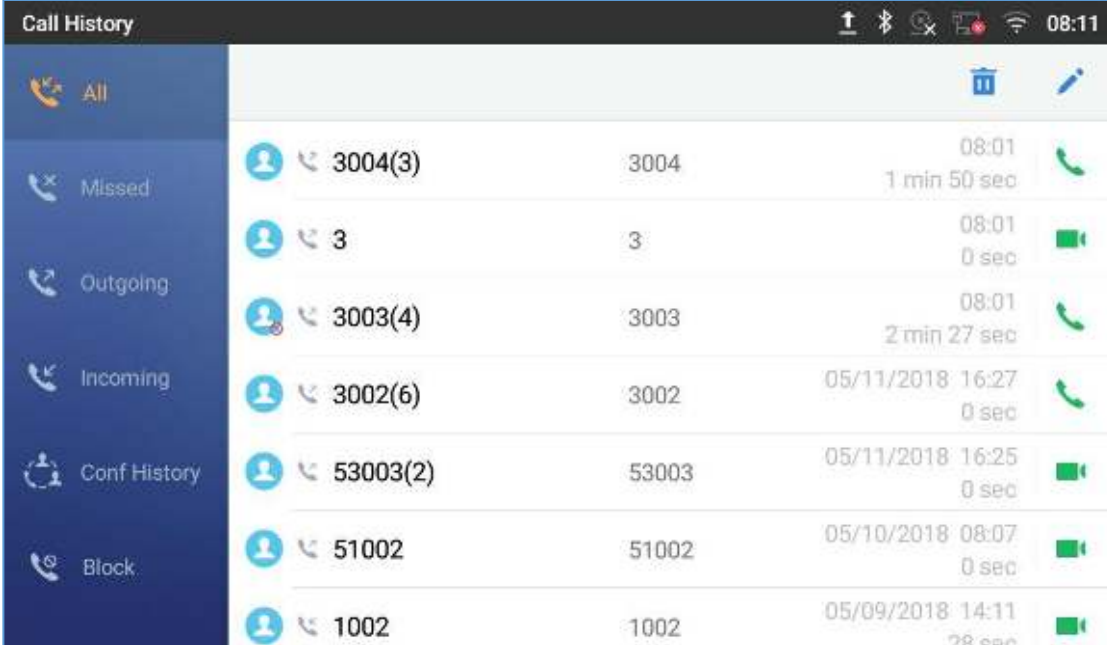

Figure 109: Intercept Anonymous Calls

CALL HISTORY

The GXV3370 supports local and BroadWorks XSI Call history. Tap  on idle screen to access Call history. The following figure shows the call history on the GXV3370.









Category	Contact	Phone Number	Date & Time	Duration	Status
All	3004(3)	3004	08:01	1 min 50 sec	Incoming
All	3	3	08:01	0 sec	Outgoing
All	3003(4)	3003	08:01	2 min 27 sec	Incoming
All	3002(6)	3002	05/11/2018 16:27	0 sec	Incoming
Conf History	53003(2)	53003	05/11/2018 16:25	0 sec	Outgoing
Block	51002	51002	05/10/2018 08:07	0 sec	Outgoing
Block	1002	1002	05/09/2018 14:11	28 sec	Outgoing

Figure 110: GXV3370 Call History

Local Call History

There are four different categories in the local call history. Users could tap on the icon on the top menu to access the corresponding call logs:

-  All
-  Missed
-  Outgoing
-  Incoming
-  Conf History
-  Block (if any)

Dial Out from Call History

Tap on one of the call history entry to call this number directly. The phone will use the same account as the call log when dialing out.

Call History Options

- Touch and press the call history entry for about 2 seconds until more option window pops up
- Users can edit this number before calling, add this number to contacts, add this number to blacklist etc....

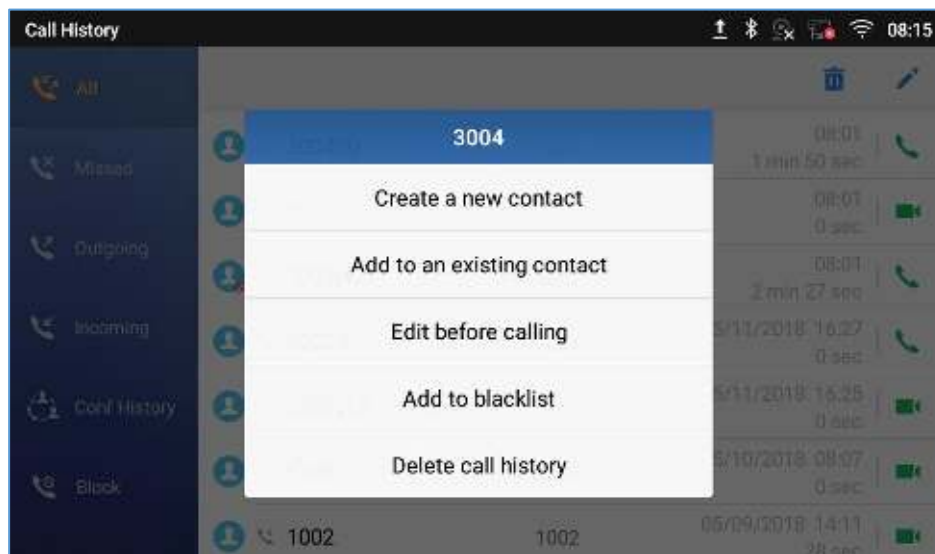



Figure 111: GXV3370 Call History – Options

Delete Call History



- **Delete the entire call history**

Users can delete the complete call history by pressing the  directly after accessing the call history page.

- **Delete a single call history entry**

Users can delete a single call history entry by pressing the entry for about 2 seconds to bring up the options then select Delete call history.

- **Delete multiple call history entries**

- Press on  the top right corner of the screen and select the entries to be deleted
- Tap on  to delete the entries.

Call History Details

For each call history entry, users could tap on the entry to access the details.

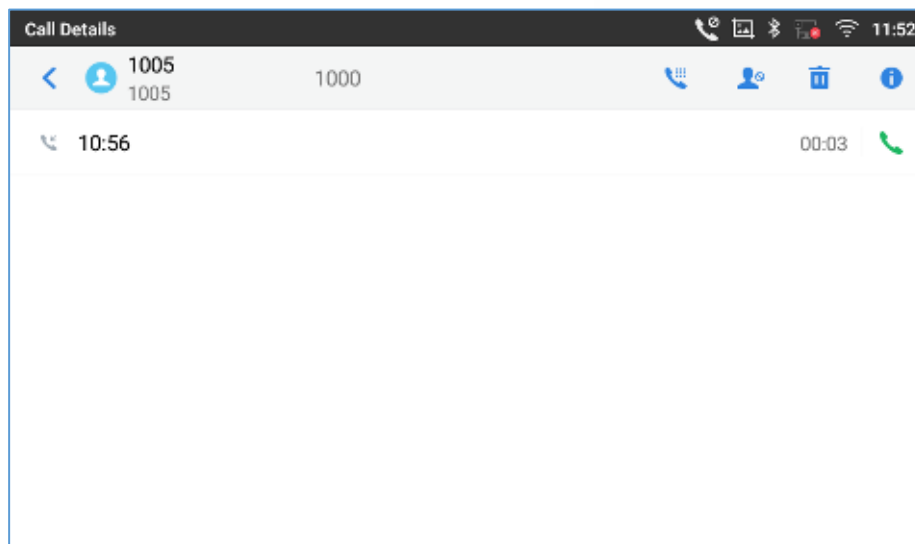







Figure 112: GXV3370 Call History - Details

Users could find the following call details by tapping on the entry:

- **The Call date:** the time when the call was initiated.
- **The Call duration:** The period of time when the call was in progress.
- **The type of the call:** Specifying if the call was a Video or an Audio Call.

Note: Call details under conference history include the previous details of the conference and for each one of the participants.

The following operations could be done:

-  Dial out this number directly.
-  Bring up dial screen with the call history number. Users could edit the number before dialing out.
-  Add to Blacklist
-  Delete the entry.
-  Options , "Create a New Contacts", "Add to an Existing Contact".

SMS

The GXV3370 has built-in SMS application to send/receive message if the SIP server and the other party support SMS message. Users can create, edit draft, delete, and check the storage status of SMS.

Tap on  from the phone's desktop to launch SMS application.

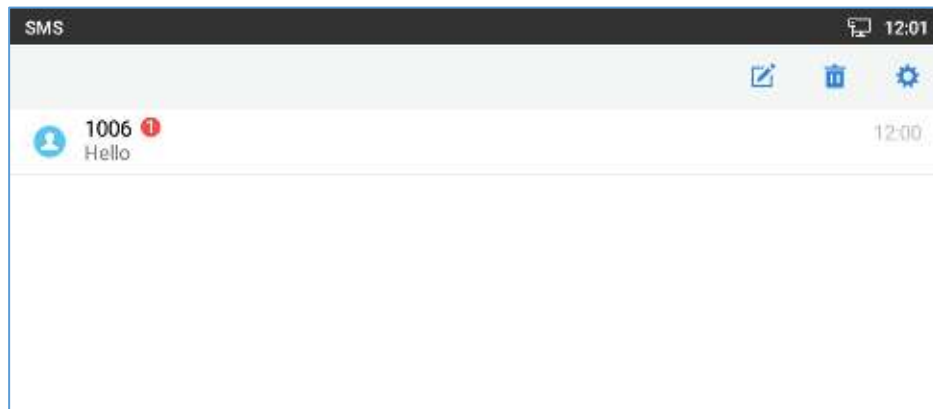

Figure 113: GXV3370 SMS Message

View SMS

On the SMS list screen, tap on one of the message to view the SMS details.

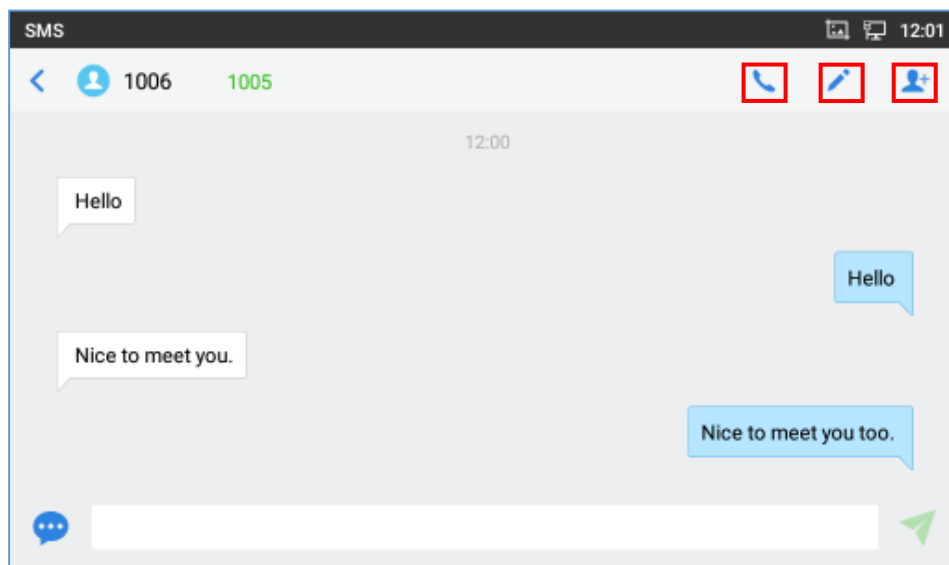





Figure 114: View SMS Dialog

- Users can press on  in order to make a call to the account's number on that conversation.
- Users can press on  in order to “delete”, “lock”, “unlock” or forward a message or a batch of messages from the conversation.
- Users can press on  in order to add the number as a contact in the GXV3370.

Create New SMS

Tap on  in SMS application to start composing a new message.

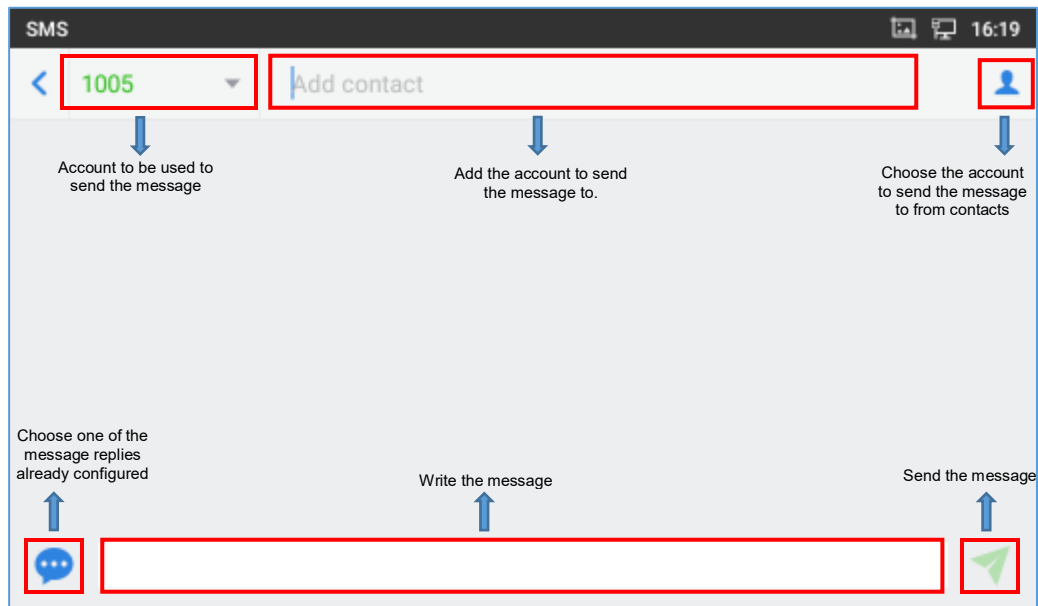





Figure 115: Create a New SMS

1. Select account to send the message from. (**Note:** Only registered accounts will be shown on the selection drop-down list, if you cannot find your account then make sure it is registered).
2. Enter the account number to send the SMS message to:
 - Add number to send the message to.
 - Enter the Number/Name of an existing contact to send the message.
 - Users could also select contact from GXV3370 Contacts by tapping on “Contacts” icon  on the upper right of the page. See Figure 89.
3. Input content: Enter the message content on the bottom field of the screen. Tap on "Done" from the Keyboard once finished.
4. Send message: Tap on the arrow icon when you are ready to send the message out.

Delete SMS

1. Users can press and hold one SMS message in a conversation for about 2 seconds until a prompt appears where “Delete” can be pressed in order to delete the chosen SMS message.
2. In order to delete one conversation, users can press and hold the conversation for about 2 seconds until a prompt appears where “Delete” can be pressed in order to delete the chosen SMS message.
3. Users can delete a batch of conversations by pressing on , then the conversations can be selected in order to delete them by pressing the same icon.

SMS Settings

Users can verify the SMS Settings by pressing on “Settings” icon  from the conversations screen.

- **Storage Status:** The SMS app supports up to 1000 messages, “storage status” helps users to verify the current number of messages on the GXV3370 and the storage space that still available.
- **Enable Quick Reply:** Enable this feature in order to automatically send a quick reply when an incoming call is rejected.
- **Choose a quick reply message:** Users can add more quick reply messages by clicking on , and choose the one that will be used and sent automatically when an incoming call is rejected.

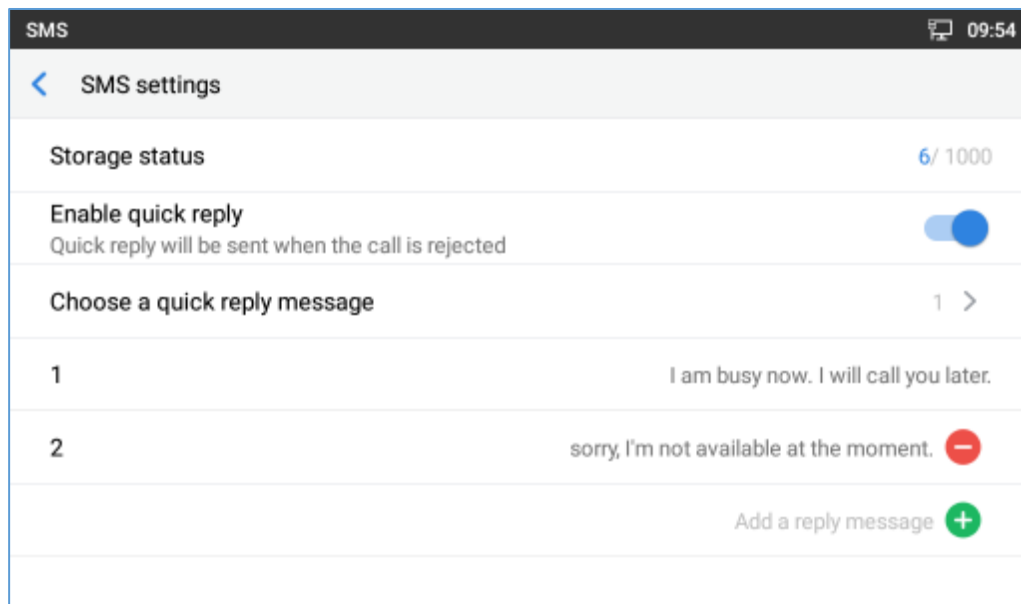

RECORDER

GXV3370 Recorder application allows users to record audio and access recording files from call recordings.

There is no time limit on the recorder as long as there is enough space to save the recording file. Tap  on the phone's desktop to launch the Recorder application.

Call Records

During an active call, users have the option to record the conversation. The recorded conversation can be retrieved from the recorder application. The account and date are specified in each record's file name.

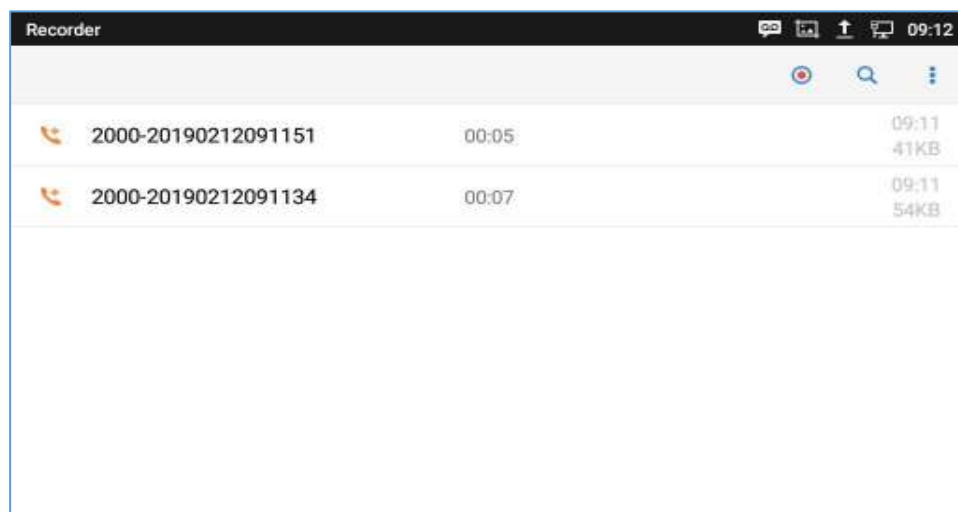





Figure 116: Recorder Application

Audio Records

To use the recorder app to record audio, tap on  open the recorder.

1. Tap on  to bring the recording page
2. Tap on  to start recording

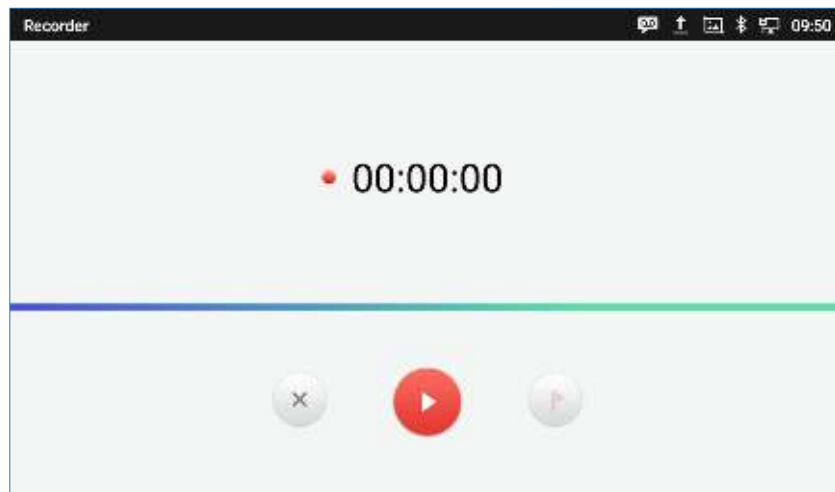



Figure 117: Recording audio

- Users can tap on  during the recording to mark a section of the conversation (a red flag will be displayed besides the record's file name to indicate that it is marked)

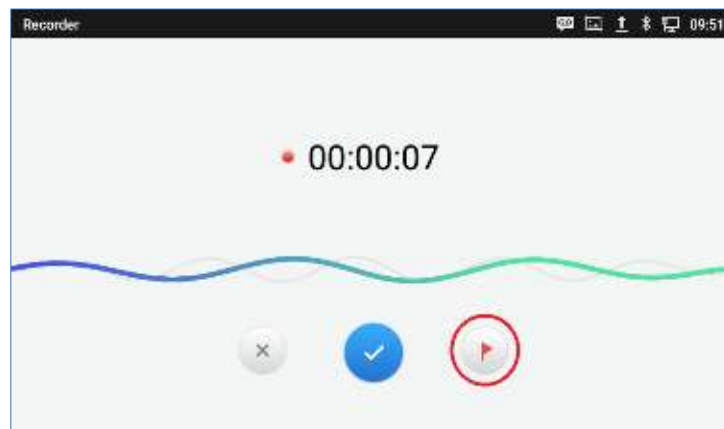



Figure 118 : Flag Mark

- Tap on  to cancel the recording, or on  to end the recording. The file will be saved and accessible under Recorder application. Users can tap on the recording file to play the recording.

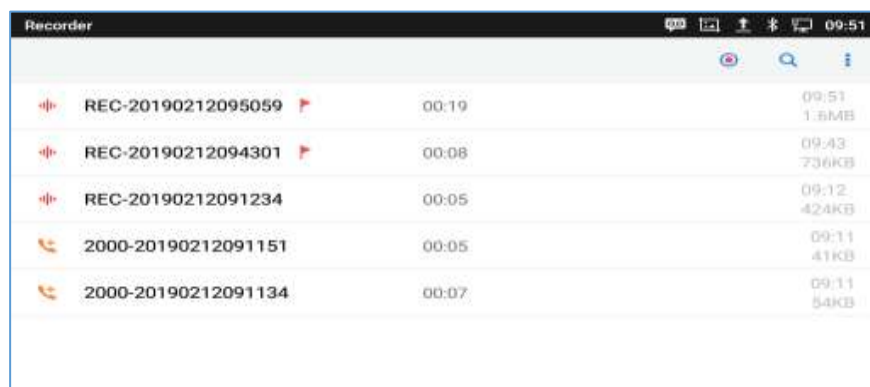



Figure 119: Recorded files

Recorder Settings

User can view the information about storage status, Enable/Change a password for accessing the Recorder application by taping on  followed by **Settings**:

1. From the phone's desktop page click on  to open the recorder.

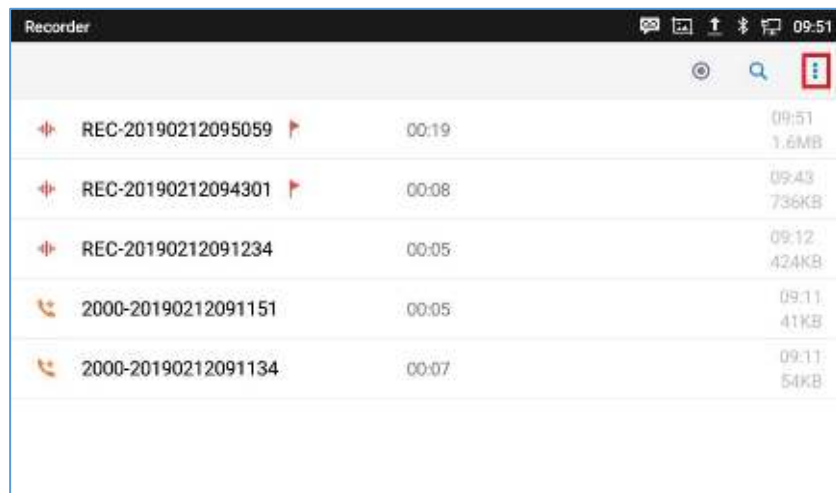

Figure 120: Recorder Menu

2. Click on **Menu** icon on the top right as shown above
3. Tap on **Settings**

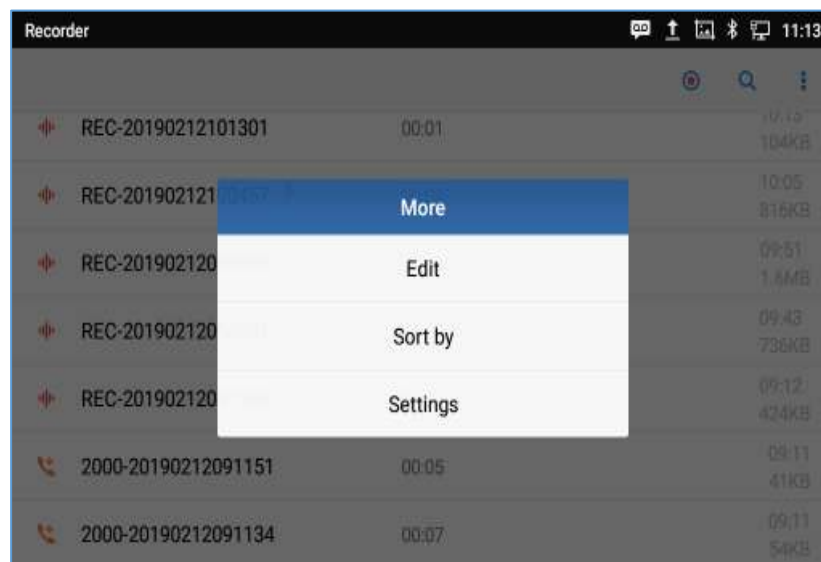

Figure 121: Menu options

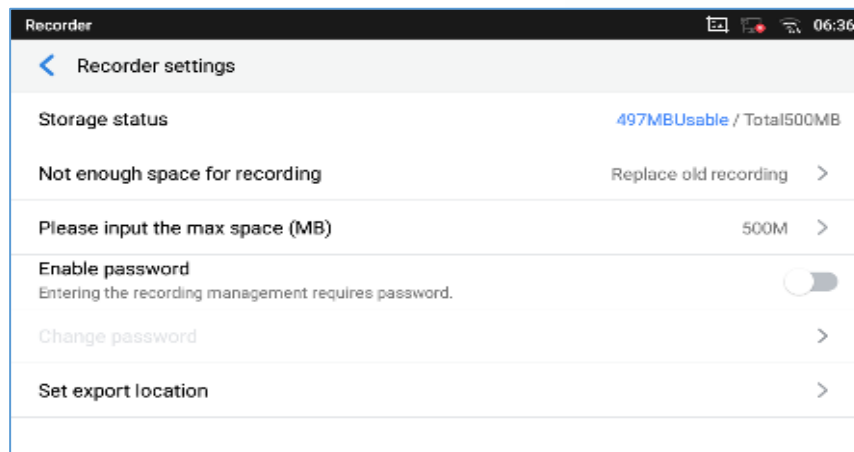

Figure 122: Recorder Settings

- Users can enable and choose a password to be set for accessing the Recorder application by tapping on **Enable Password**:

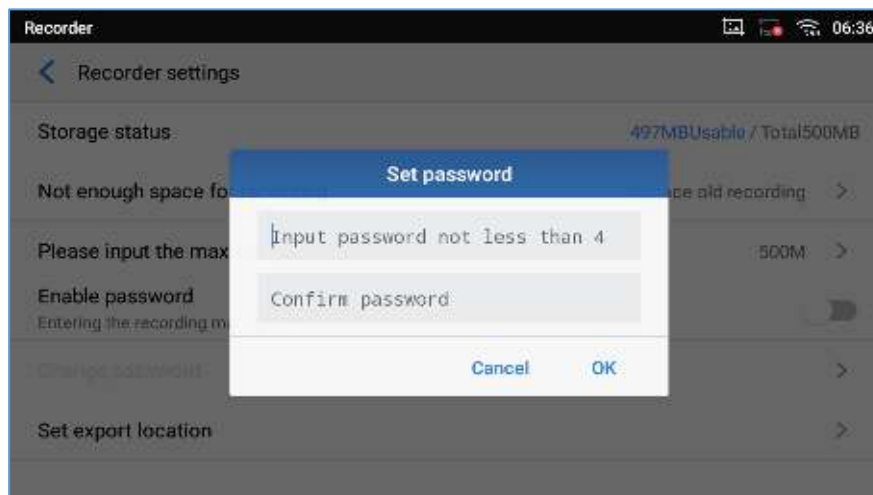

Figure 123: Password Set

- Users can change the preconfigured password by tapping on **Change password**:

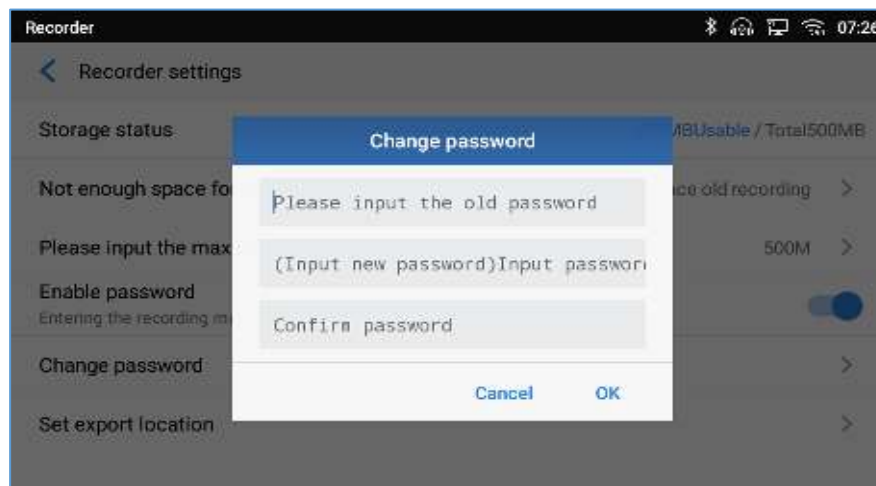

Figure 124: Change Password

Files operations

Users could long press on each file to select it then perform the following operations on the select file.

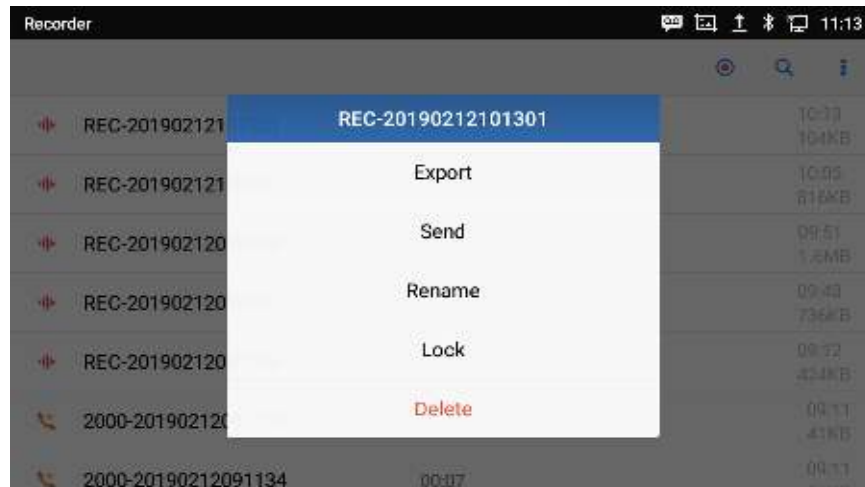

Figure 125: Files operation





Export: Choose this option to export the file to other storage destinations (SD card as example).

Lock/Unlock: Users could lock and unlock the file.

Send: Make sure to enable Bluetooth on the phone in order to send the file to other devices.

Rename: Click on this option in order to rename the file.

Delete: Choose this option to delete a file

Users can **Export**, **Send** or **Delete** recordings alternatively by pressing on the Menu key , click on **Edit** and then select the file to operate on (choose  for file export,  to send via Bluetooth or  to delete)

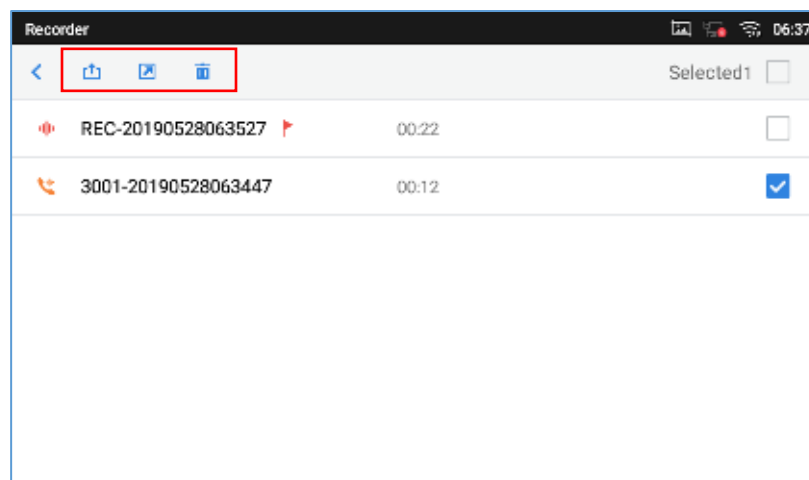

Figure 126: Export/Send/Delete files

Diagnostics

General Status

The General Status page shows the current Port status as well as the Network Status of the phone. Here as shown below:

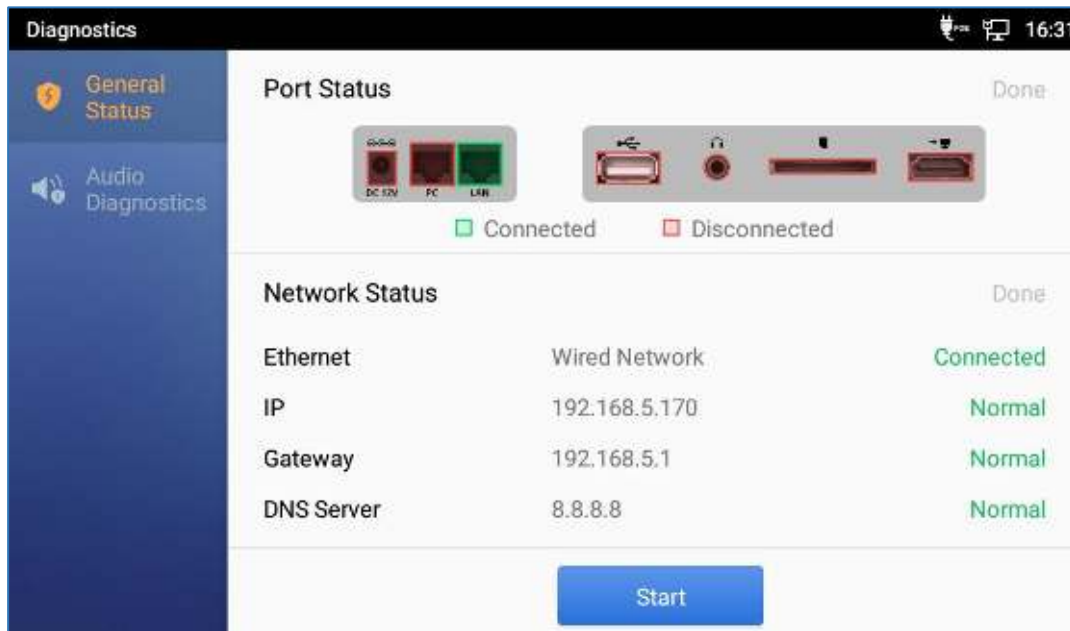

Figure 127: General Status

Users can run a General Diagnostic test by pressing on start button to begin updating the details. When beginning the test, the screen will look like this:

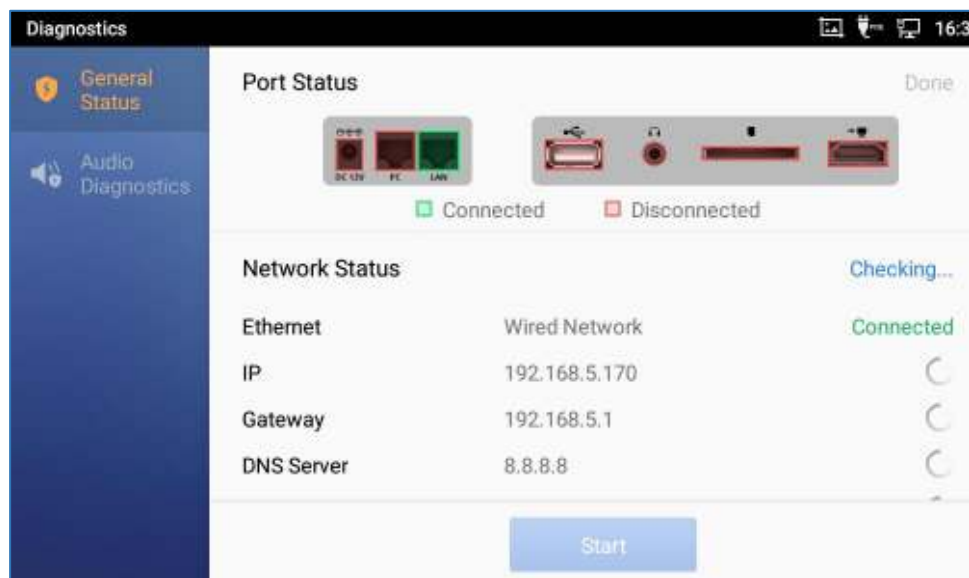

Figure 128: Start the General status Diagnostic

Audio Diagnostics

The Audio Diagnostics page allows users to perform test for Speaker and Microphone. To start the Speaker Diagnostic test press on the Start button as shown below:

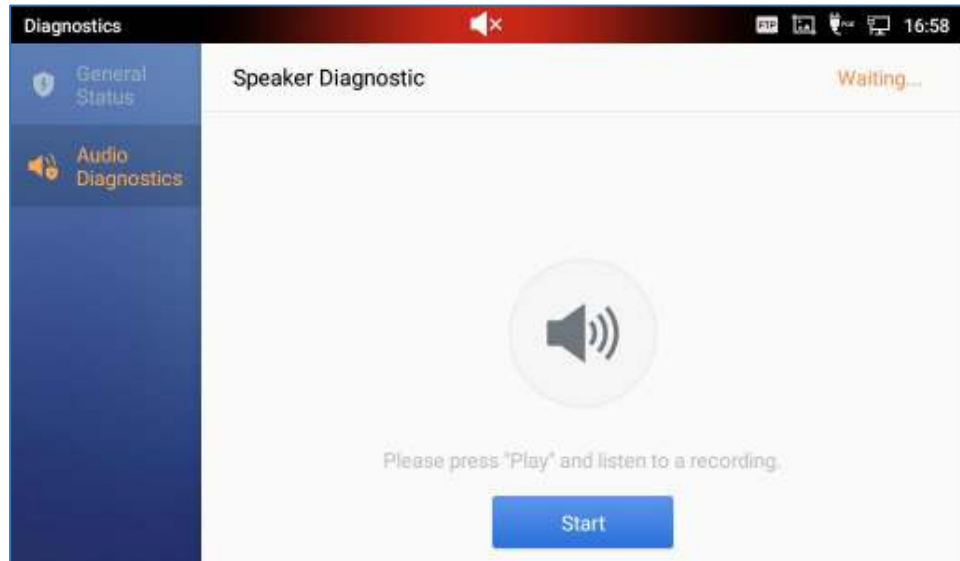

Figure 129: Speaker Diagnostic

When pressing Start an audio clip will start playing and you should be able to hear it

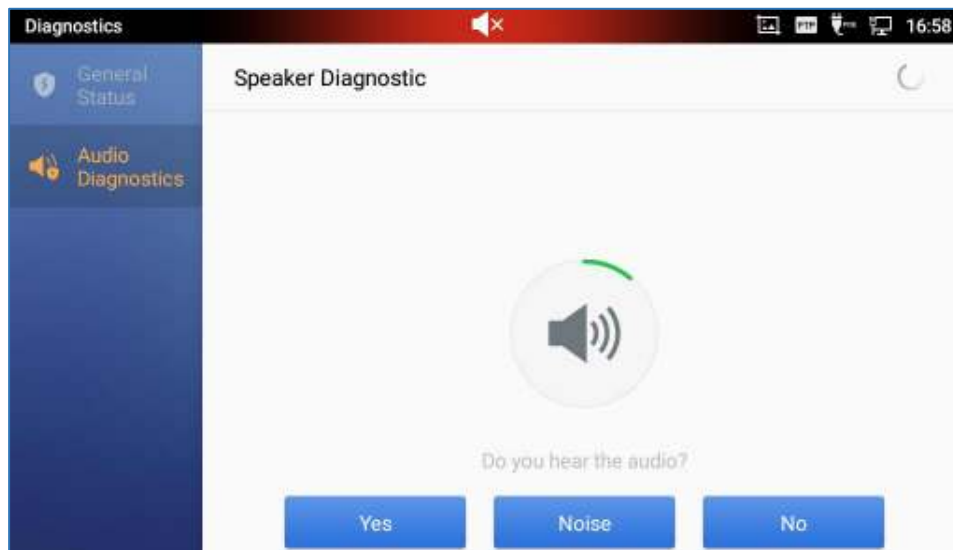

Figure 130: Ongoing Speaker Diagnostic

Once the audio is finished, you may select your reply based on your hearing experience, press:

- ➔ Choose Noise: if you noticed a noise on the audio clip played, this will show a “Abnormal”
- ➔ Choose No: if you were not able to hear any audio coming from the speaker, however, make sure that the volume is up. This will also show as Abnormal status next to the Speaker Diagnostic.

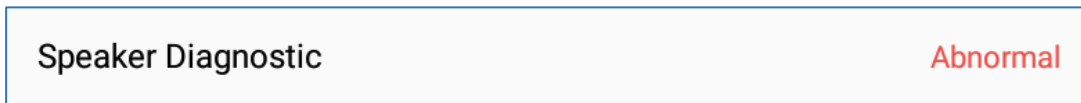

Figure 131: Abnormal status

- ➔ Choose Yes: if the audio was heard without issue and this will show a “Normal” Status next to speaker Diagnostic

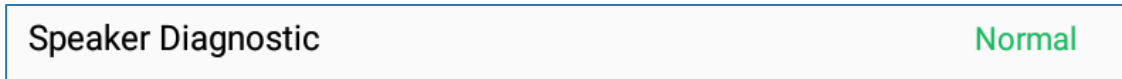

Figure 132: Normal Status

Once the Speaker Diagnostic is done with Normal status as a result, it will trigger the Microphone test automatically, and the user can press Start button to begin performing the test:

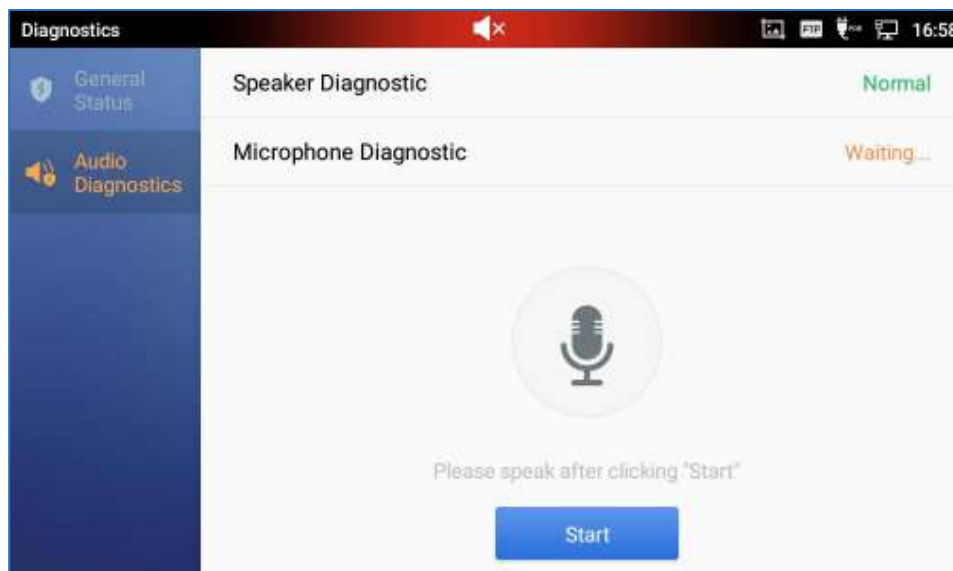

Figure 133: Microphone Diagnostic

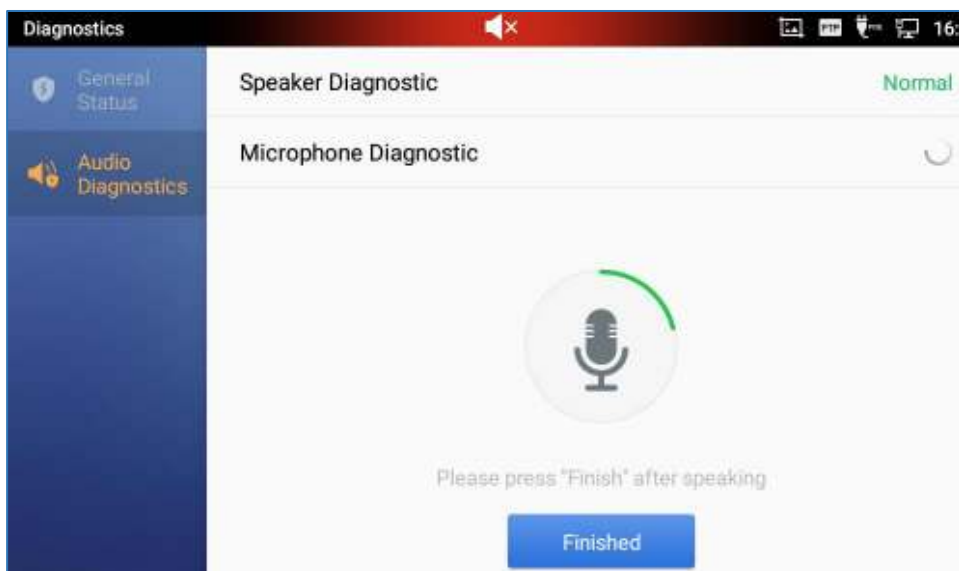

Figure 134: Recording Audio sound

Once done, Press Finished Button so that the audio recorded will be played back, and you will be able to select the feedback via Yes or No buttons.

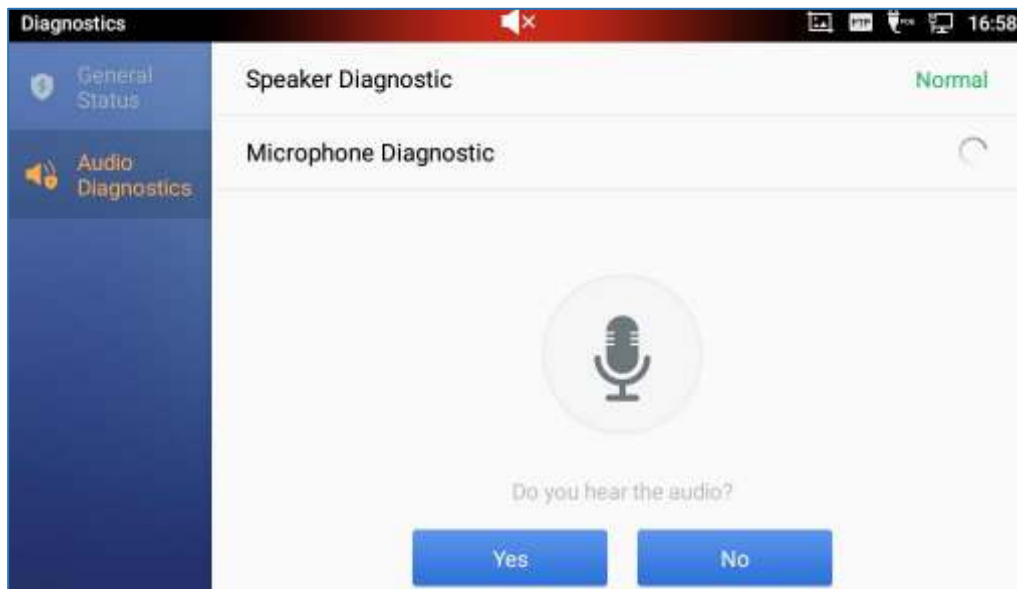

Figure 135: Microphone Diagnostic Done

Following the test, you may select the reply according to what was heard. Press:

- ➔ Yes: if the audio can be heard clearly

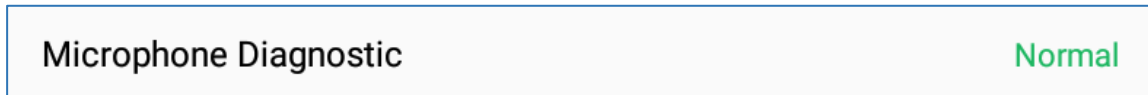

Figure 136: Normal Status

- ➔ No: if the audio was not heard.

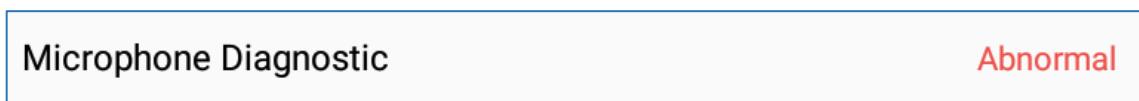

Figure 137: Abnormal Status

BACKUP AND RESTORE

Backup Data

GXV3370 Backup and Restore Built-in application is used to back up data or import backup files to restore data. It can be accessed from the application screen. The default screen will list available backup files (if any) and backup options

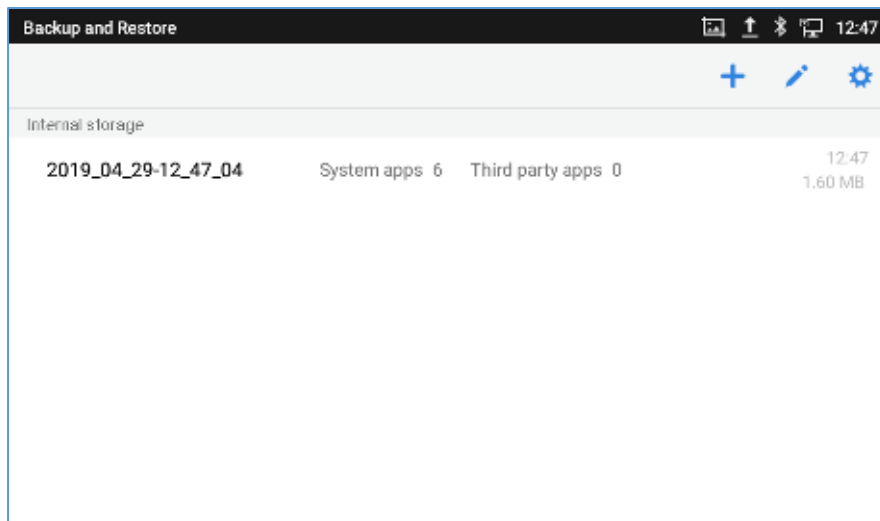



Figure 138: GXV3370 Backup App Main Screen

Press the **+** option to create new backup. The user will select data and press  option to start backup.

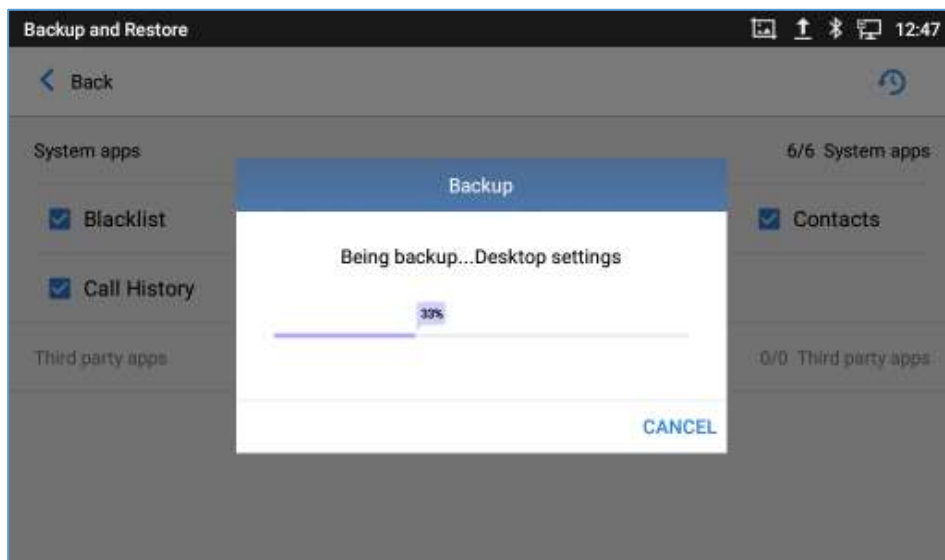



Figure 139: GXV3370 Backup App Main Screen

The device would gather the information and save it in **File Manager app -> Internal Storage -> Backup**.

Restore Backup Data

After Backup is complete successfully, Users can access the GXV3370 Backup and Restore main screen and select the Backup point from the list, after selecting the system apps to be restored from the Backup file, the Restoring process will be triggered after selecting  and pressing on Confirm, during the process; All buttons and panel drop-down will be disabled and the device will reboot when the process is done.

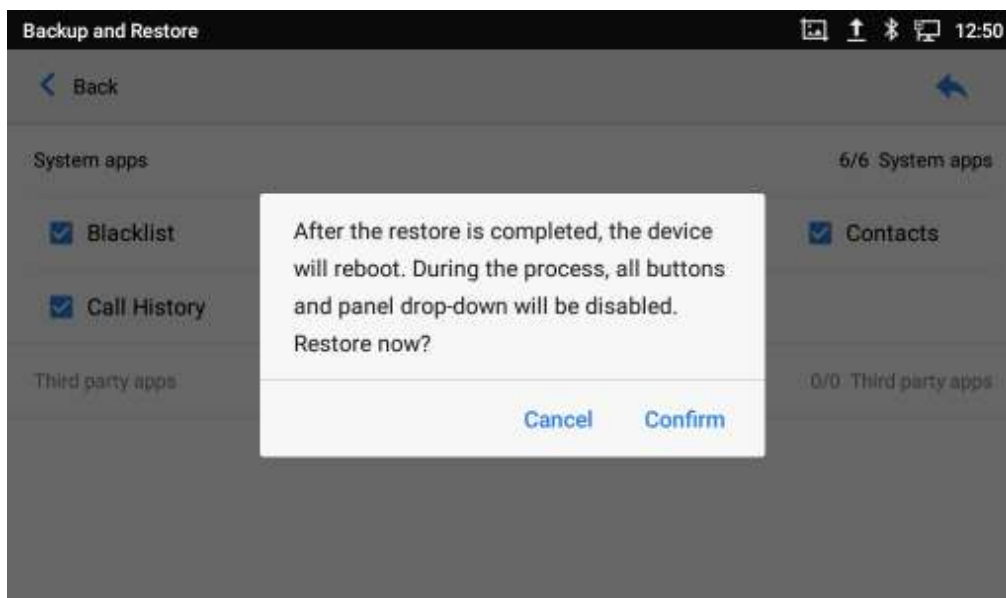



Figure 140: Restore Backup Data

FILE MANAGER

File Manager is a tool that allows users to delete, move, copy/past, send and rename files. It helps users to access and manage files in local storage as well as external storage devices (e.g., SD card/USB flash drive). Tap  on the phone's menu or desktop to launch File Manager application.

Files Operations

Copy and Paste Files

Follow the steps below to copy and paste a file on the GXV3370:

1. Open file manager and navigate to the directory of the file to be copied. Touch and press on the file for about 2 seconds until the options window pops up then press Copy.
2. Select the location to which you want to paste the file and press on  .

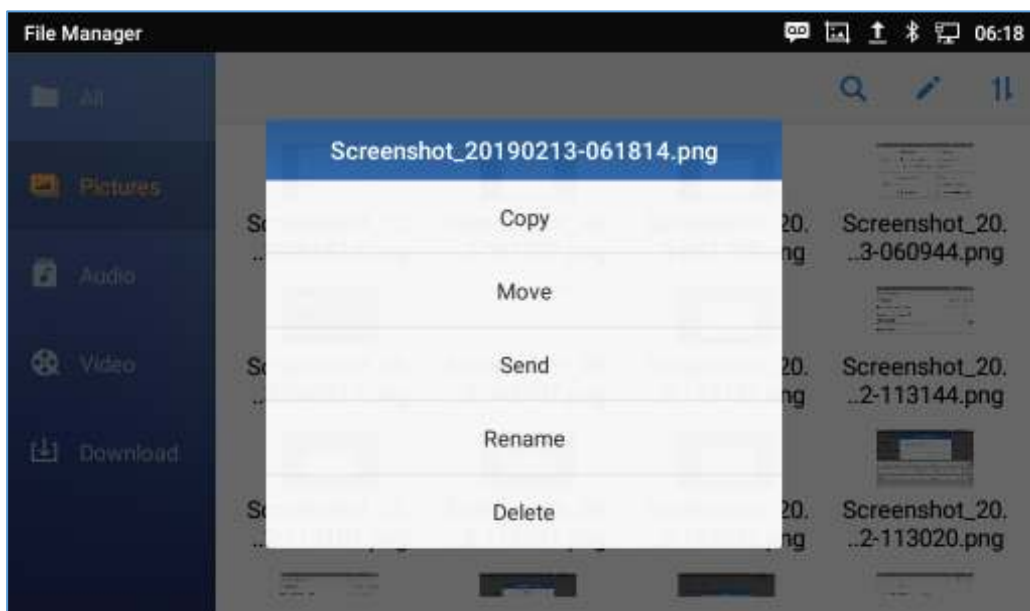





Figure 141: GXV3370 File Manager – Copy File

Or

1- Press  on the top right corner of the screen and select the files to copy

2-Tap on  to copy the files selected

3-Select the directory to which you want to paste the files then press  .

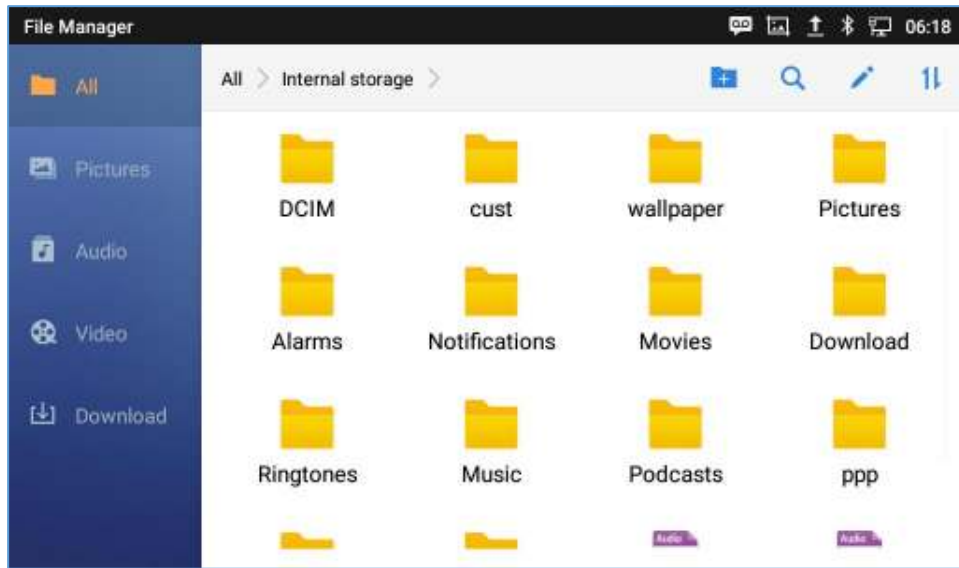



Figure 142: Paste File

Move Files

The steps to move a file are similar to the steps to copy/paste a file. The difference is once the file is moved, the file will not be kept in the source folder. Follow the steps below to move a file on the GXV3370.

1. Open file manager and navigate to the directory of the file to be moved. Touch and press on the file for about 2 seconds until the options window pops up then press Move.
2. Select the location to which you want to past the file and press on 

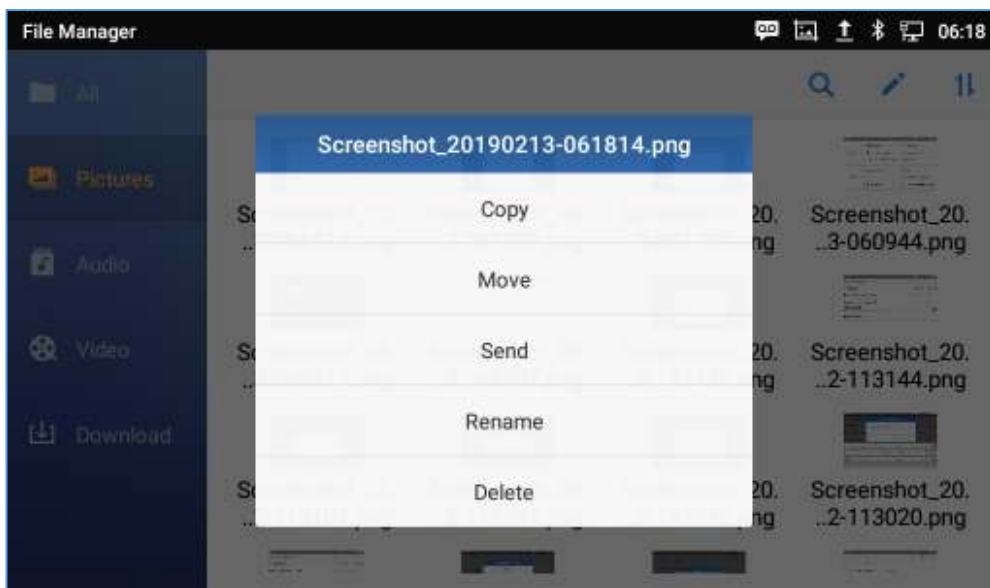

Figure 143: GXV3370 File Manager - Move



Send Files

The users can send a file via Bluetooth. Please make sure Bluetooth is turned on and connected to the Bluetooth devices. Otherwise, users will be directed to set it up before the file can be sent out.

To send a file:

1. Open file manager and navigate to the directory of the file to be sent over. Touch and press on the file for about 2 seconds and press send
2. Select the Bluetooth device to which the file will be transferred

Or

1. Open file manager and navigate to the directory of the file to be sent over then press on 
2. The check boxes will appear then check the files to be sent over
3. Press on  to send the selected files via Bluetooth then choose the Bluetooth devices to send the files to.

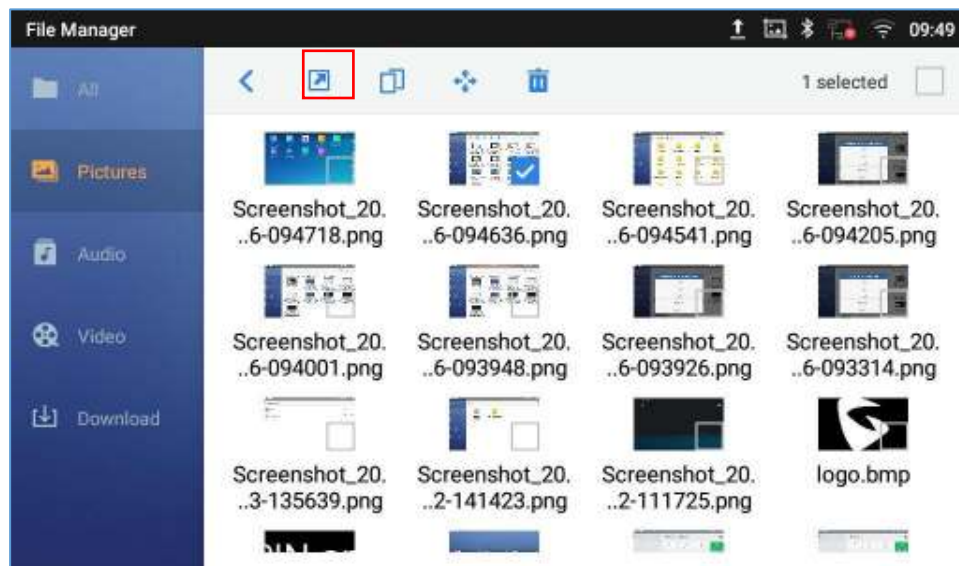

Figure 144: GXV3370 File Manager - Options

Delete Files

1. Open file manager and navigate to the directory of the file to be deleted. Touch and press on the file for about 2 seconds until more options appear.
2. Scroll down and select “Delete”

Or

1. Open file manager and navigate to the directory of the file/files to be deleted the click on 



2. The check boxes will appear then check the files to delete
3. Press on  to delete the files selected
4. Tap on **OK** to confirm

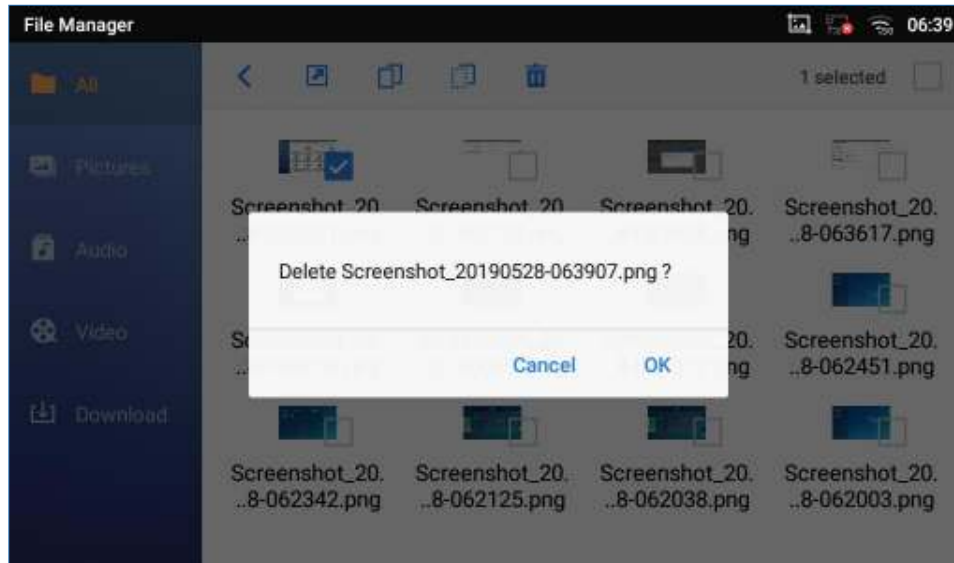

Figure 145: Delete File(s) via File Manager

Rename a File

1. Open file manager and navigate to the directory of the file to be renamed. Touch and press on the file for about 2 seconds until more options appear
2. Tap on "Rename". A new dialog window will pop up for users to enter the new name.
3. Tap on **OK**.

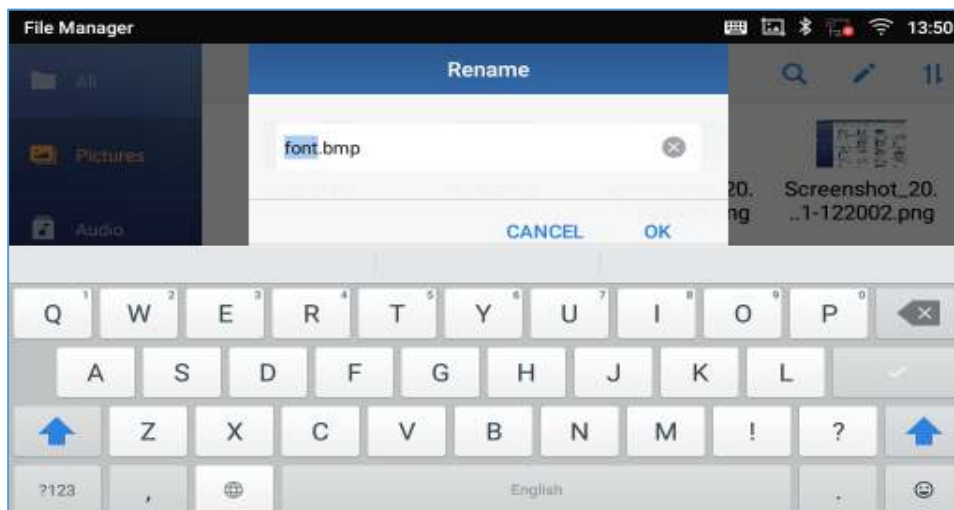

Figure 146: Rename File

File Categories

The file manager will categorize the files stored on local/external storage based on the type of files. The available categories are

- **All:** gives access to all internal storage files as well as external storage devices
- **Pictures:** contains all the pictures stored on the phone including screenshots, camera pictures and external pictures
- **Audio:** contains all the Audio file on local and external storage
- **Video:** contains all the videos stored on the phone including recorded videos from camera and videos stored on external devices
- **Downloads:** in this category the phone will list all the downloaded files such as apps, document, music, videos ...etc.



GS MARKET

The GXV3370 supports extensive amount of 3rd party Android applications. Users could install those applications from the built-in GS Market.

Tap on  at the phone onscreen menu to launch the GS Market. Users could browse, search, download and install the apps from there for tools, games, and other applications.

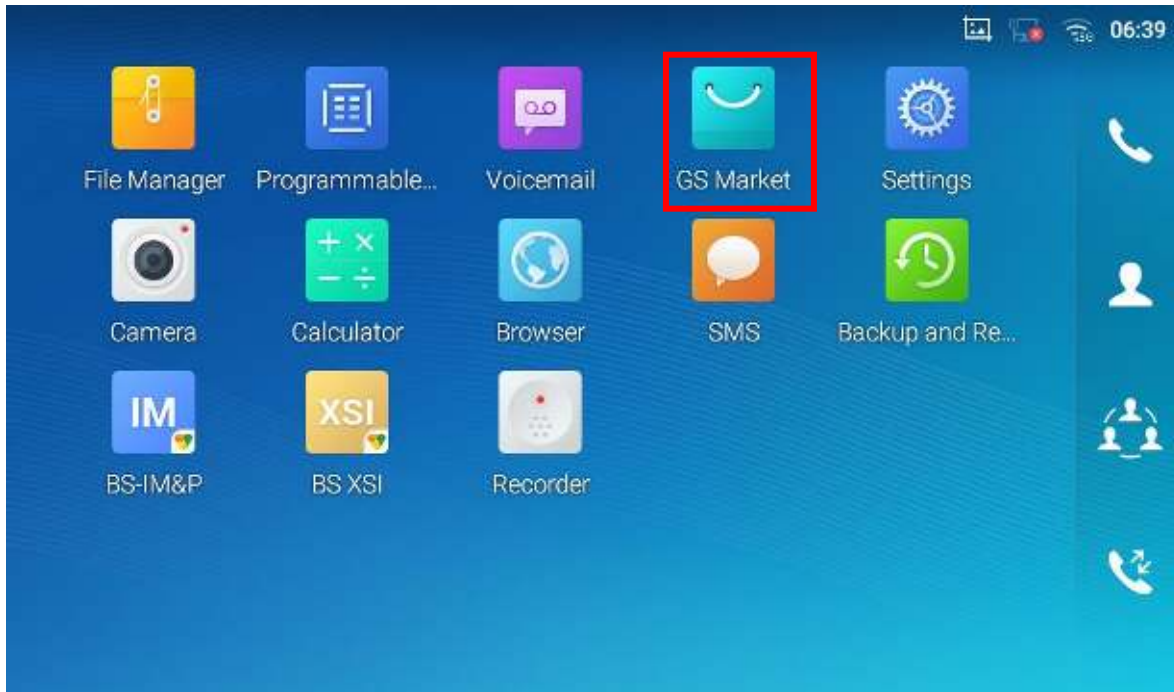

Figure 147: GS Market - Onscreen Menu

FTP SERVER

The GXV3370 supports file transfer via FTP server. Once installed, users could access the GXV3370 file system from PC. In order to access FTP Server application, go to GXV3370 application screen → File

Manager, and click on the icon .

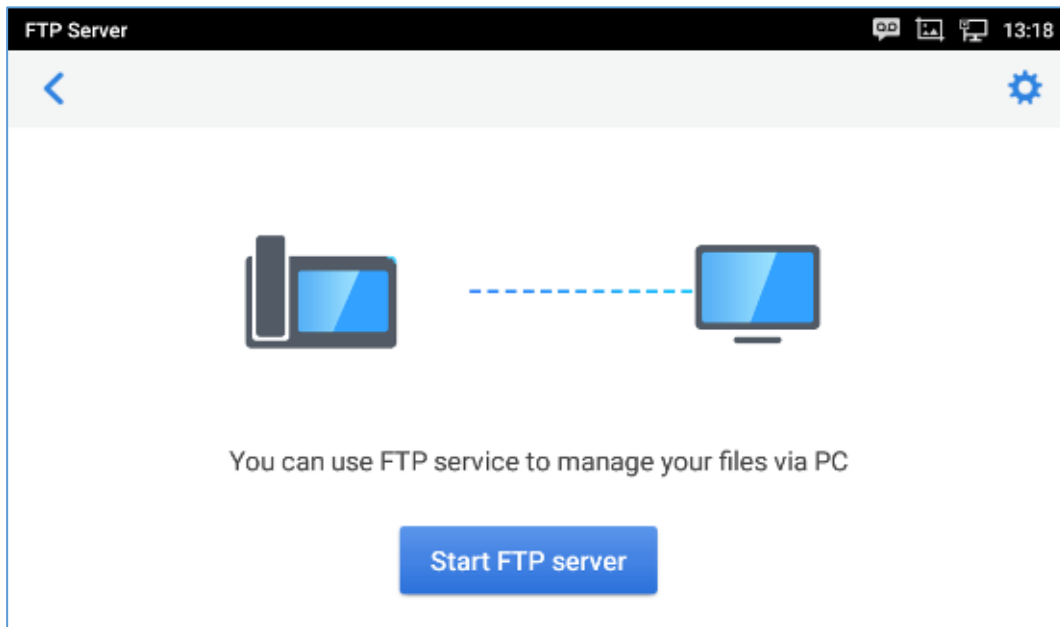

Figure 148: FTP Server – Start

Tap on "Start FTP Server" to turn the server on. The FTP server address URL will be provided on the screen.

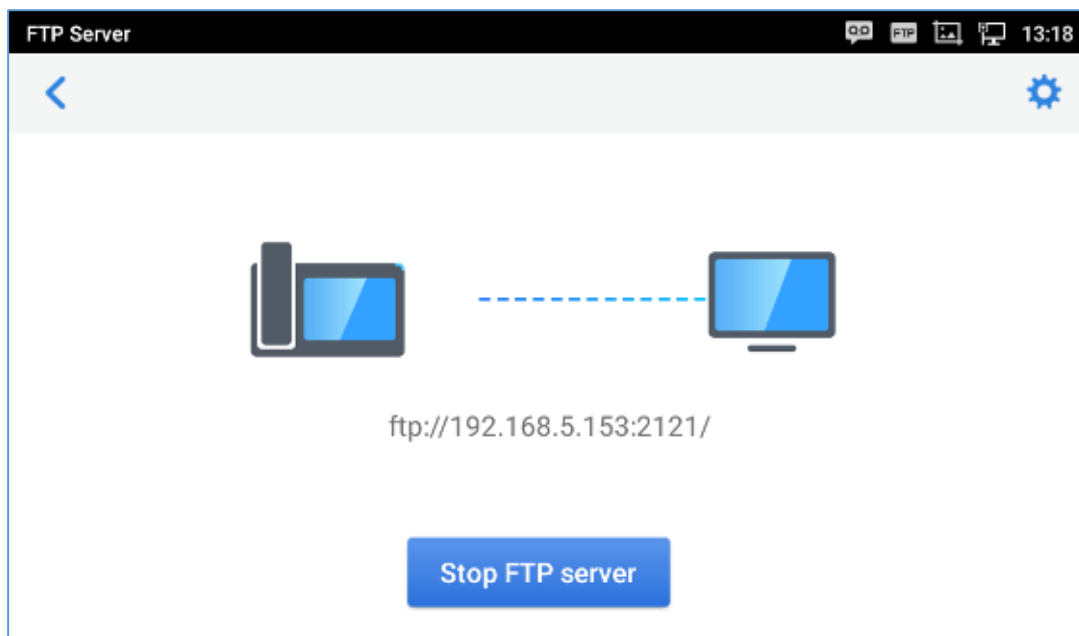



Figure 149: FTP Server – Stop

For security purpose, users could also tap on  in the above figure to set up username, password, port number and directory for remote access. By default, when the users access the ftp server from a PC, a prompt will show asking for username and password. The default username and password are "admin".

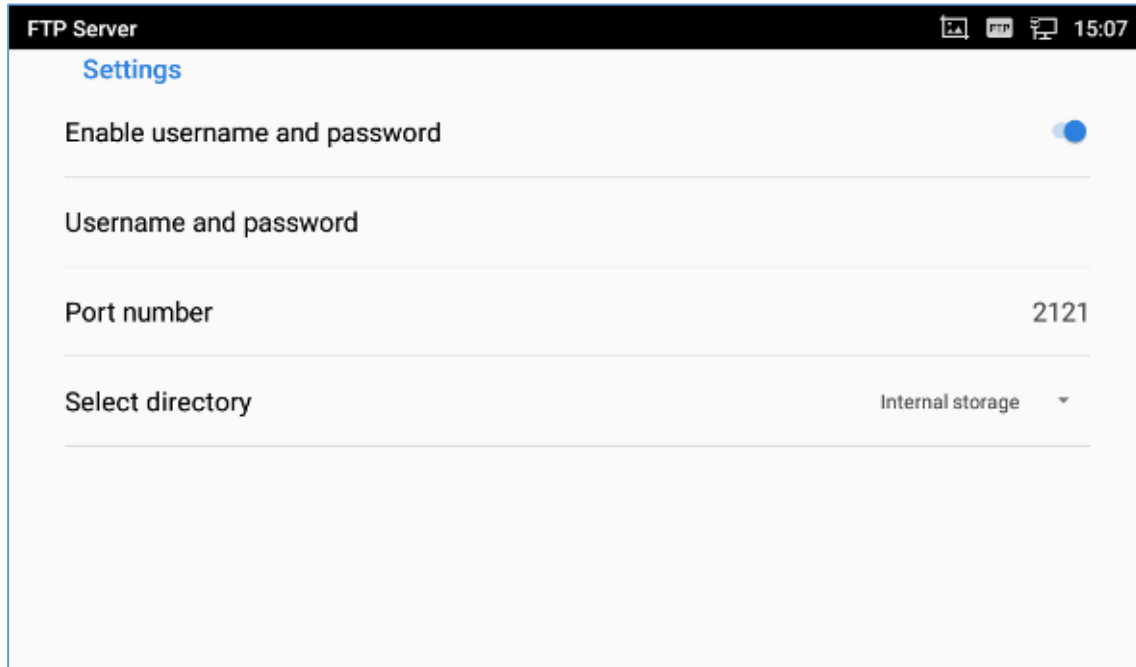

Figure 150: FTP Server – Settings

CAMERA

The GXV3370 has built-in Camera to support taking pictures and recording videos. The camera can be used for SIP video calls or video calls via 3rd party applications.

Note: During SIP video calls or video calls via 3rd party applications, the camera cannot be accessed to take pictures or videos.

To access Camera to take pictures and videos, tap on Camera icon  on idle screen.

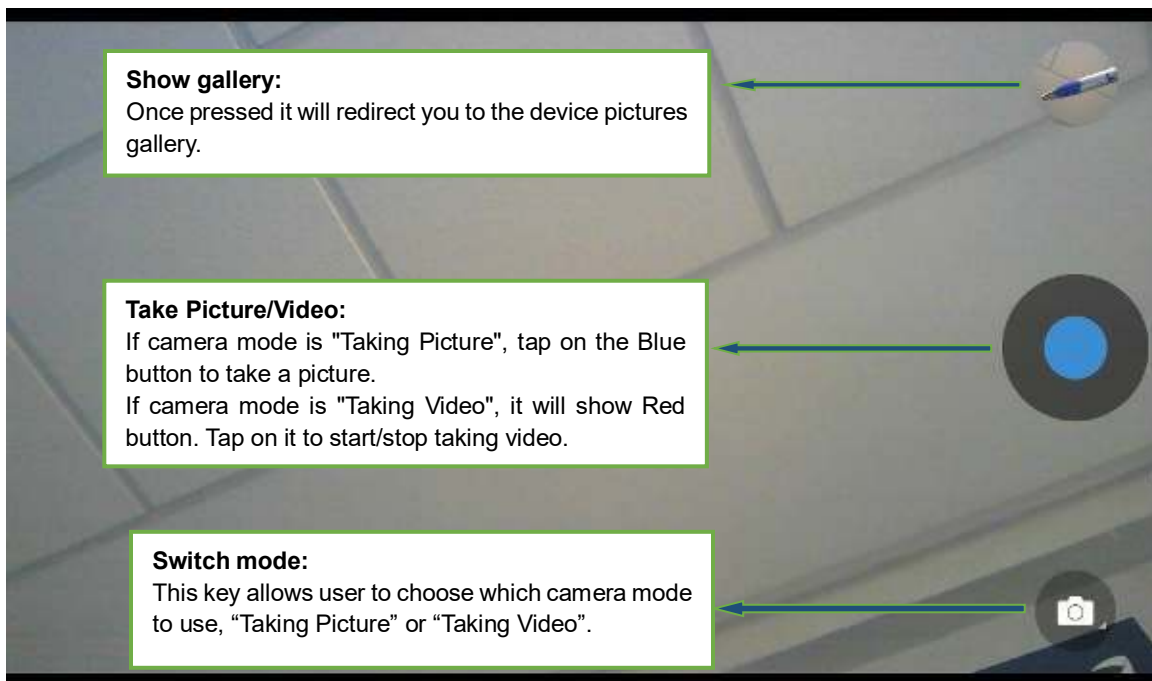





Figure 151: GXV3370 Camera

Take Picture

1. Press  to take picture.
2. The captured picture can be accessed under **File Manager** → **Internal Storage** → **DCIM** → **Camera**.
3. To view the last taken pictures, swipe from right to left on camera screen.

Record Video

1. Swipe from left to right on camera screen or press menu button, then tap on  then type on  to select the video mode.

2. Tap on  to start recording.
3. The recorded video can be accessed under **File Manager** → **Internal Storage** → **DCIM** → **Camera**.
4. To view the last recorded videos, swipe from right to left on camera screen.

Angle Adjustment

On the back of the GXV3370 camera, users could scroll the wheel up/down to adjust the camera angle. If users scroll the camera all the way up until the icon  shows up on the status bar of the screen, the camera is turned off.

Gallery

The GXV3370 has built-in Gallery for users to view pictures and play videos from GXV3370 internal storage. Users could also perform basic editing tasks on pictures under Gallery page.

To access the recently taken pictures or recorded videos, click on the circular key on the right top corner of the camera screen.

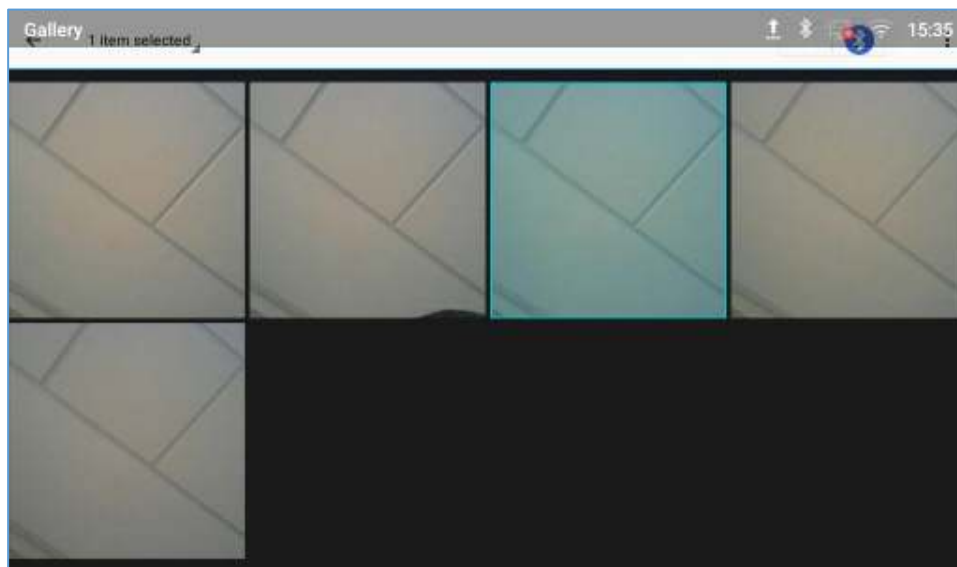



Figure 152: Recent pictures and videos page

On this page, users have the ability to perform operations, such as:

- Tapping on  button to share the file via Bluetooth or a 3rd party application.
- Tapping on  button to edit and customize pictures. Users can add filters, crop, rotate pictures... etc.

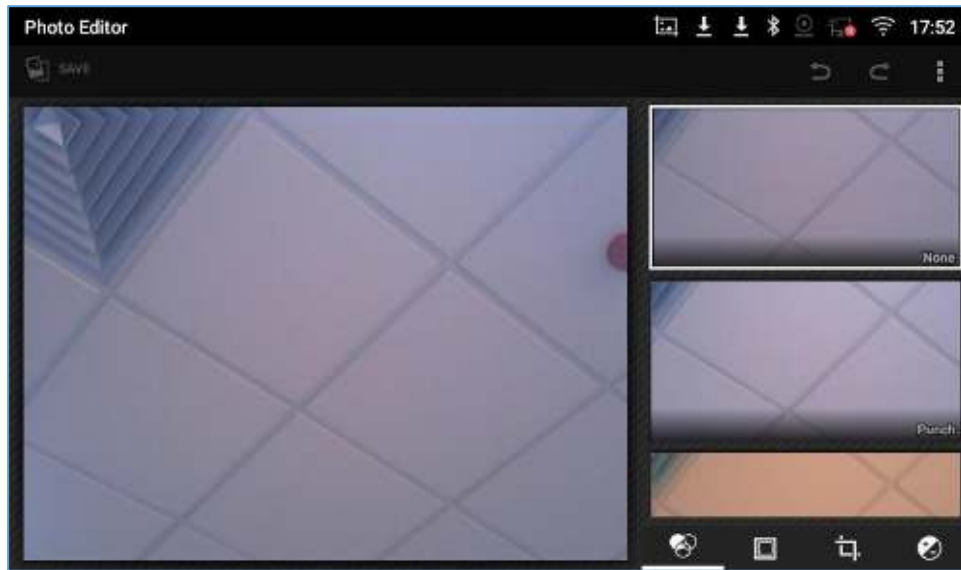

Figure 153:Edit picture

Note: Videos cannot be edited from the gallery

- **Gallery page**

To access the Gallery, open the camera click on the circular key on the right top corner of the camera screen.



Figure 154: Access to the Gallery

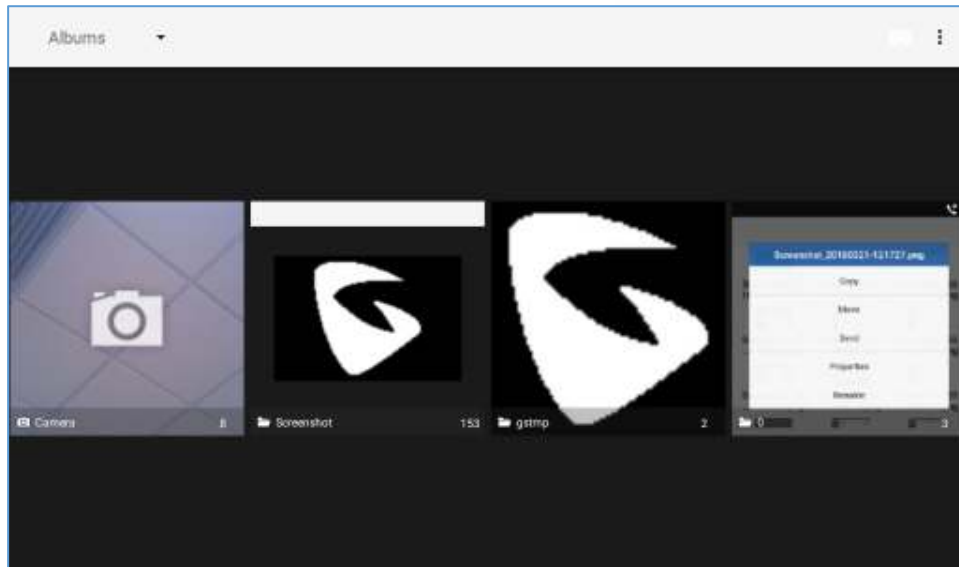

Figure 155: GXV3370 Gallery

On this page from the upper left corner, users can sort the pictures and videos by Album, Location or Time.

- **View pictures**

Access one album of pictures and videos and select "Grid View" or "Filmstrip View" from upper left corner of the screen to set view mode of the pictures. Tap on a specific picture to view the picture in full screen.

- **Pictures Options**



When the picture is displayed in full screen, press the Menu button . A list of options will be available for users to select, including "Delete", "Slideshow", "Edit", "Rotate left", "Rotate right", "Crop" or "Set Picture as", etc.



Figure 156: GXV3370 Gallery - Picture Options



- **Take picture/video**

Tap on  on the upper right of the Gallery page to start taking pictures or videos using the GXV3370 built-in camera.

- **Select multiple pictures**

Touch and press on one of the pictures for about 2 seconds until the picture is highlighted in blue.

Tap on other pictures to select multiple pictures. On the upper right of the Gallery screen, users can tap

on  to share the pictures via Bluetooth, tap on  to share the pictures via a third-party

application or tap on  to delete the selected pictures.

Screensaver

User can set screensaver from the phone's idle screen under **Settings → Basic → Display → Screensaver**.

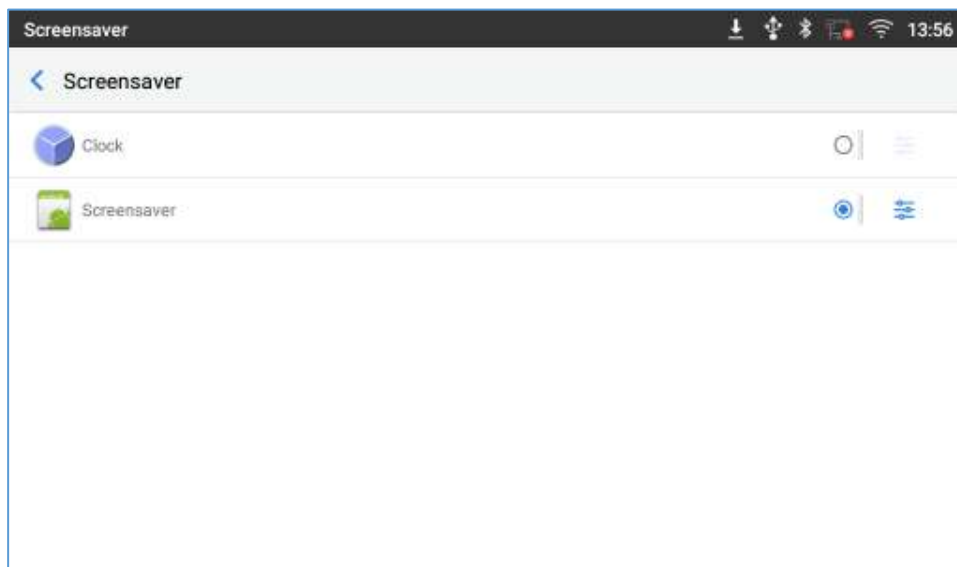



Figure 157: Screensaver settings

Users can set Screensaver to Clock or Screensaver.

- **Clock:** When setting the screen saver to Clock the phone will show a clock on the screen when the phone goes to standby mode. Press  to set the clock as Digital or Analog and Enable/Disable the Night mode.
- **Screensaver:** Users can set Screensaver from the local images, the default directory (Screensaver), or from Internal storage, or they can set a folder in a remote HTTP server to display images contained on it as screensaver. Press  to show the screensaver settings

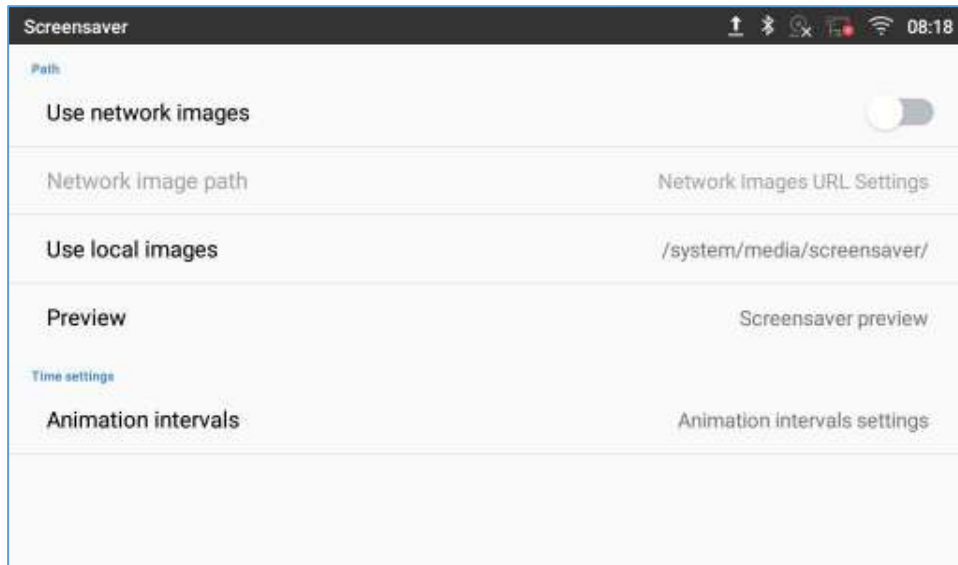

Figure 158: Use Network Images

Click on **Use network images** and set the path of the remote screensaver folder.

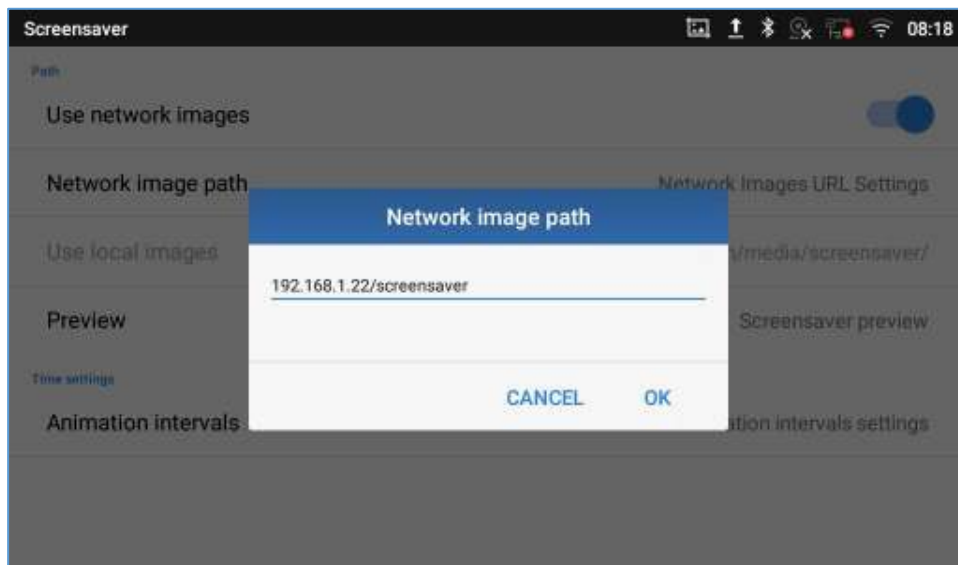

Figure 159: Network Image Path

ZOOM MODE

The GXV3370 supports zoom mode feature, this feature can be enabled under **LCD settings → Basic → Display**.

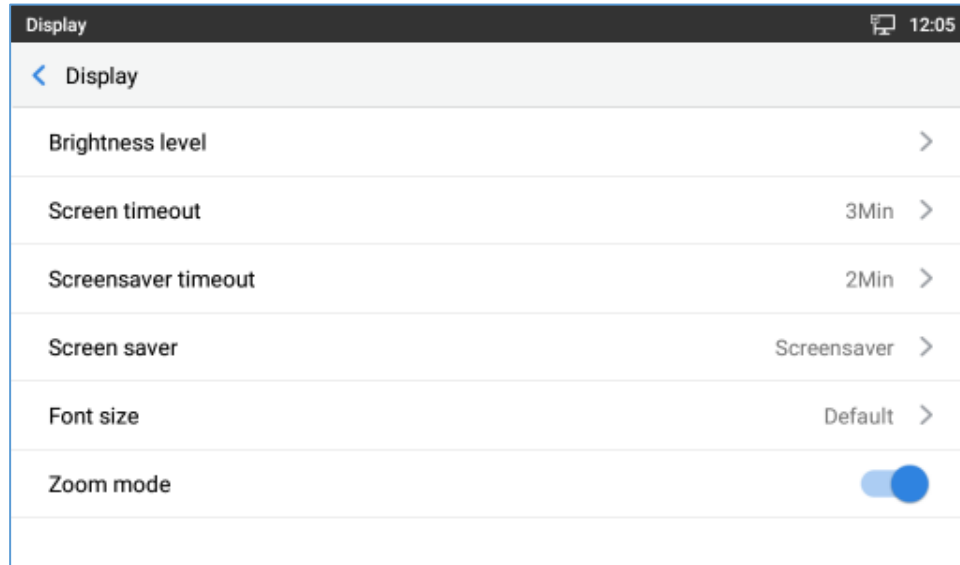

Figure 160: Zoom Mode feature enabled

When this feature is enabled, the font and icons will be displayed larger than the normal size.

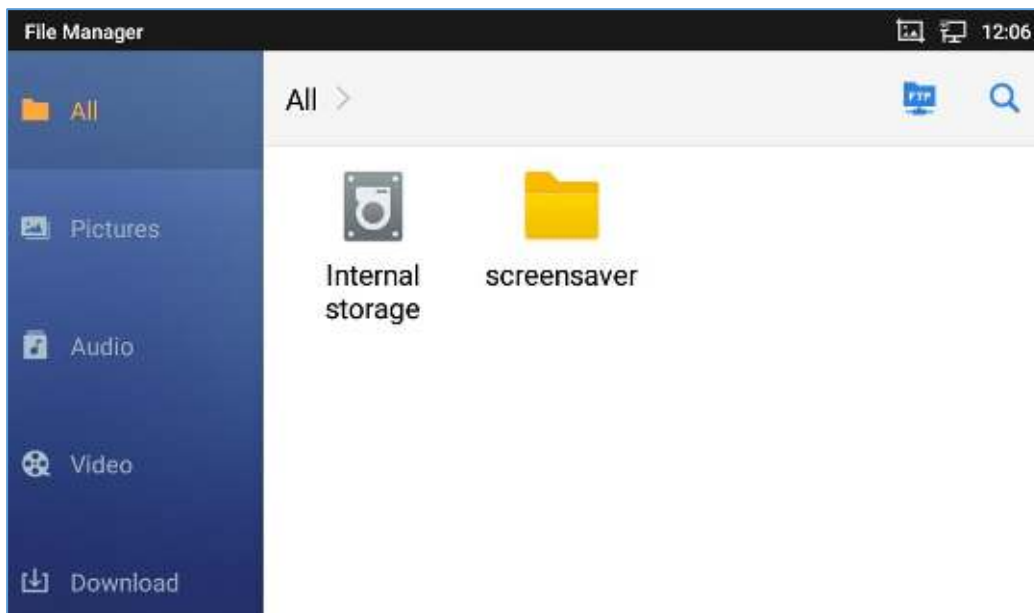



Figure 161: Example of file manager app's display after enabling the zoom feature.



BROWSER

GXV3370 browser could be used in a similar way as a PC-based web browser. Users can open web pages, bookmarks, view history, search ...etc. Tap  on the idle screen to launch the Browser application.

Note: The default page in the GXV3370's Browser is Google Search.



Figure 162: GXV3370 Web Browser

- Touch the screen and scroll up/down/left/right to view the web page.
- Use two fingers on the screen to pinch in or spreading out the page.
- Press the MENU button  to or press  to access more options including refresh New Tab, find on page, etc.

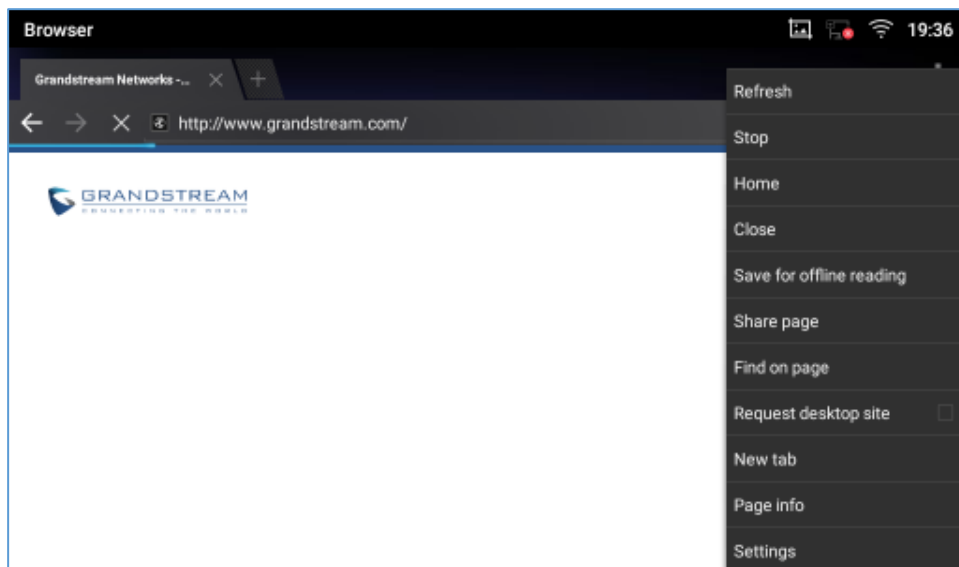

Figure 163: GXV3370 Browser Menu Options

- To open a new window, tap on  icon on the right side of the tab.



Figure 164: Open New Window in Browser

- To open **Bookmarks**, **History** and **Saved Pages**, tap the icon  on the upper right of the Browser.



Figure 165: GXV3370 Web Browser-Bookmarks

ACTION URL

GXV3370 supports ActionURL module, and it is used to set the URL for various kinds of phone events on phone web GUI, and when the corresponding event occurs on the phone, phone will send the configured URL to SIP server. To use ActionURL module, users need to know the supported events in this module, and also added the dynamic variables of the supported events on phone web GUI. The dynamic variables of the supported event will be replaced by actual values of the phone, in order to notify the event to SIP server. Please refer to GXV3370 Administration Guide and ActionURL User Guide for the configuration details.

http://www.grandstream.com/sites/default/files/Resources/ActionURL_Guide.pdf



CONNECTING GXV3370 TO DOOR SYSTEMS

The GXV3370 offers a powerful integration with Door systems (GDS3710 Door System or others) and allows users to open the door, initiates call and gets real time audio/video stream.

In order to configure the GXV3370 with the door system from the phone side, users need to go under GXV3370 Web GUI→Value-added Service→Value-added Service. *Please, refer to the GXV3370 Administration Guide for more details about Value-added Service configuration.*

Once the configuration is done, the call from the door system is answered on the GXV3370 in full screen with the configured “open door” button to send the access password to the door system. *Please, refer to the following figure:*

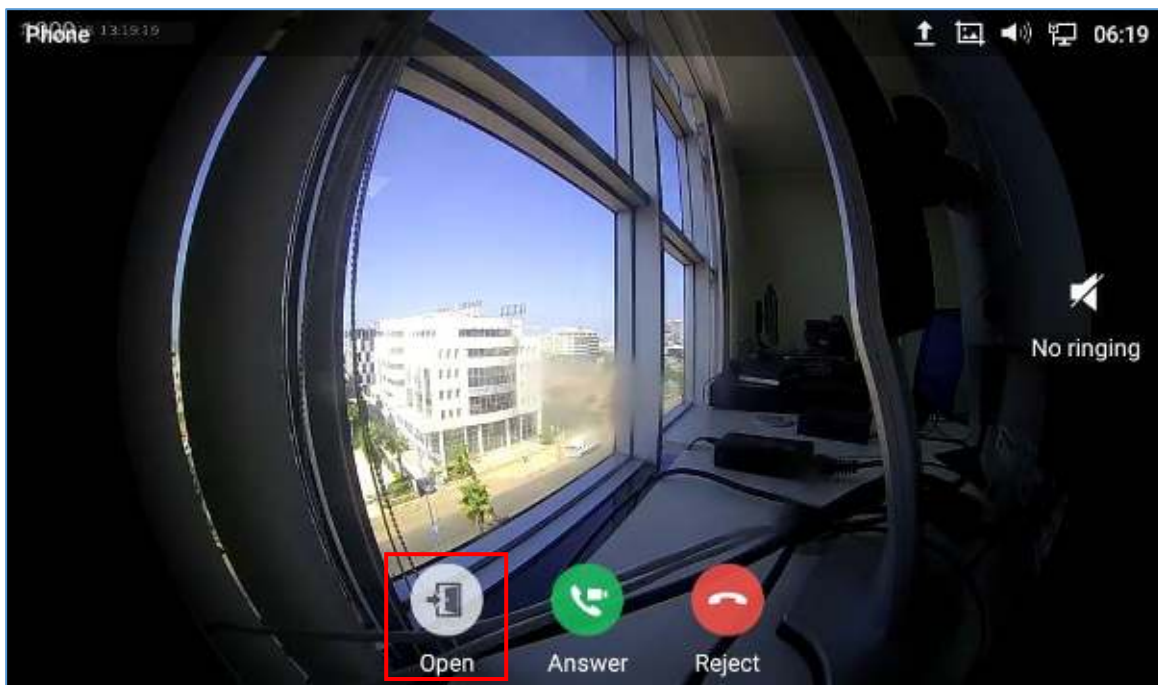

Figure 166: Incoming call from GDS3710 door system

The GXV3370 can be connected with the door system in two different ways, either using peering mode (without a SIP server) or through a SIP server. For more details, please refer to following guide describing the steps to connect the GXV3370 to GDS3710:

http://www.grandstream.com/sites/default/files/Resources/Connecting_GDS3710_with_GXV3370.pdf

CONNECT TO NETWORK AND DEVICES

The GXV3370 supports a variety of network connections (Ethernet, Wi-Fi) and device connections, including EHS headset (Plantronics), USB, SD card and Bluetooth device. Users can connect the GXV3370 and transfer files from/to the GXV3370 using a USB connection, SD card or Bluetooth.

Ethernet

Ethernet connection is turned on as DHCP by default. If you would like to use Ethernet connection for network access, please make sure the Ethernet cable is plugged in to the LAN port on the back of the GXV3370.

To configure Ethernet settings on GXV3370 LCD:

1. Go to GXV3370's **Settings** → **Network** → **Ethernet Settings**.
2. Touch **IPv4 settings**.
3. Tap on "IPV4 Address Type" to select DHCP, Static IP or PPPoE as the address type.
 - For DHCP, save the setting and the GXV3370 should be able to get IP address from the DHCP server in the network.
 - For static IP, enter IP Address, Subnet Mask, Default Gateway, DNS Server, and Alternative DNS server for the GXV3370 to correctly connect to network.
 - For PPPoE, enter PPPoE account ID and password so the GXV3370 can get IP address from the PPPoE server.

WI-FI

WI-FI is supported and built-in on the GXV3370. GXV3370 can be connected to network if Wi-Fi is available within the area.

Turn On/Off Wi-Fi

1. Go to GXV3370's **Settings**.
2. Touch **Network**.
3. Check or uncheck the option for **Wi-Fi**.

Or, users could open the top status bar and tap on Wi-Fi icon  to turn it on/off.

Connect to Wi-Fi Networks

1. Once Wi-Fi is turned on, GXV3370 will automatically start the scanning within the range.
2. Go to GXV3370's **Settings**.



3. Touch **Network**.
4. Touch **Wi-Fi Settings**.
5. A list of Wi-Fi networks will be displayed as scanning result. Tap on the SSID and enter the correct password information to connect to the selected Wi-Fi network.
6. The phone will start connecting to the Wi-Fi. The status bar will show Wi-Fi signal strength.
7. Once it is added and the password is remembered, the GXV3370 will connect to it again when the SSID is within the range.

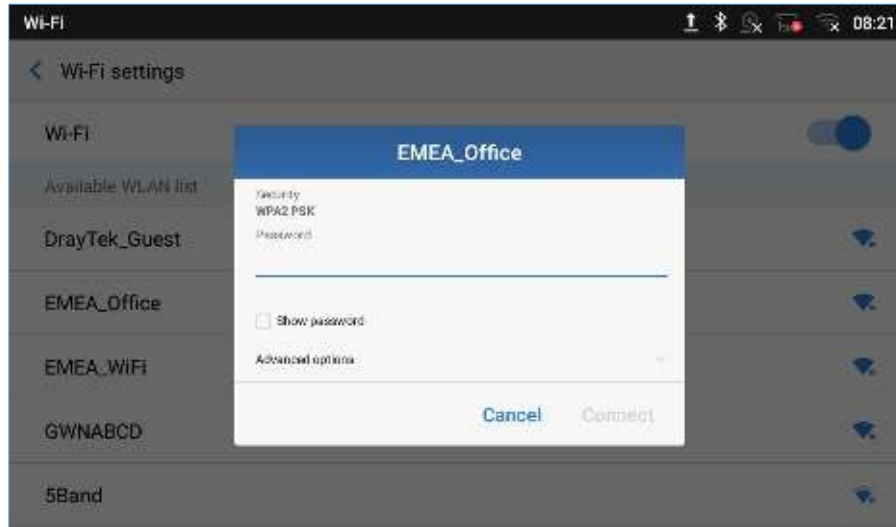

Figure 167: GXV3370 Connect to Wi-Fi

8. The previous steps allow the GXV3370 to connect the Wi-Fi network with DHCP setting by default. If it needs to be connected the Wi-Fi with static IP settings, please scroll down the setting window and tap to check the **“Show advanced options”**. Then the window will show up the IP settings at the bottom. If the Static is selected, the system will require end user to input IP address, Gateway, Network prefix length and DNS 1 and DNS 2 addresses.

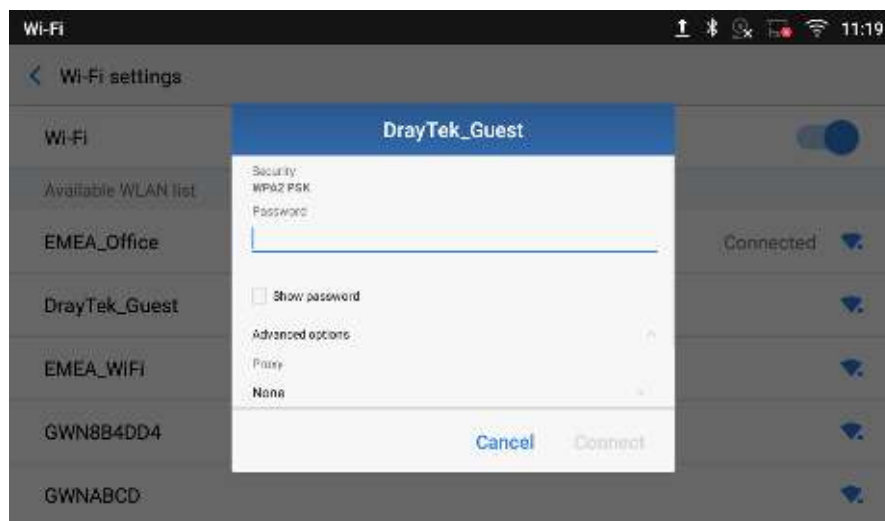

Figure 168: GXV3370 Connect to Wi-Fi-Show Advanced Options

9. If there is a need to modify the saved Wi-Fi network setting, the end user should tap and long press the SSID bar in the Wi-Fi setting page. The system will pop up a prompt and then users need to tap on **“Modify Network”**. Then, the phone system will pop up a new window to allow user to check the Wi-Fi parameters and change the setting by checking the **“Show advanced options”** at the bottom.
10. User can also add Wi-Fi Networks manually if the network is hidden or not showing on the list of scanned SSIDs. User needs to roll down the Wi-Fi settings page and press on **“Add network”** and then enter the SSID name, Security type and Password.



Figure 169: Wi-Fi - Add network

Wi-Fi Settings Shortcut

Users can enter the Wi-Fi settings by sliding the Status Bar, then long Press on the Wi-Fi icon.

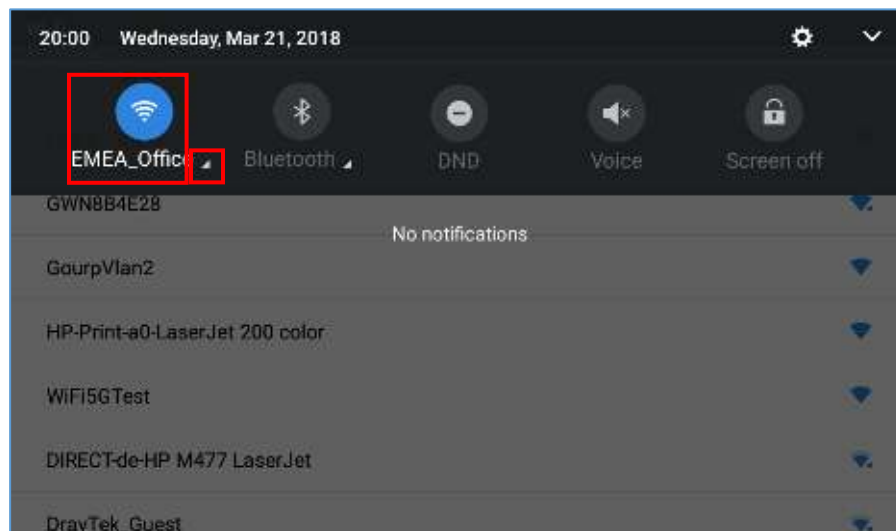

Figure 170: Wi-Fi Settings Shortcut

-Or-

Press the letter under Wi-Fi icon this will show the list of the Wi-Fi networks detected. Press “More Settings” to access the Wi-Fi settings.

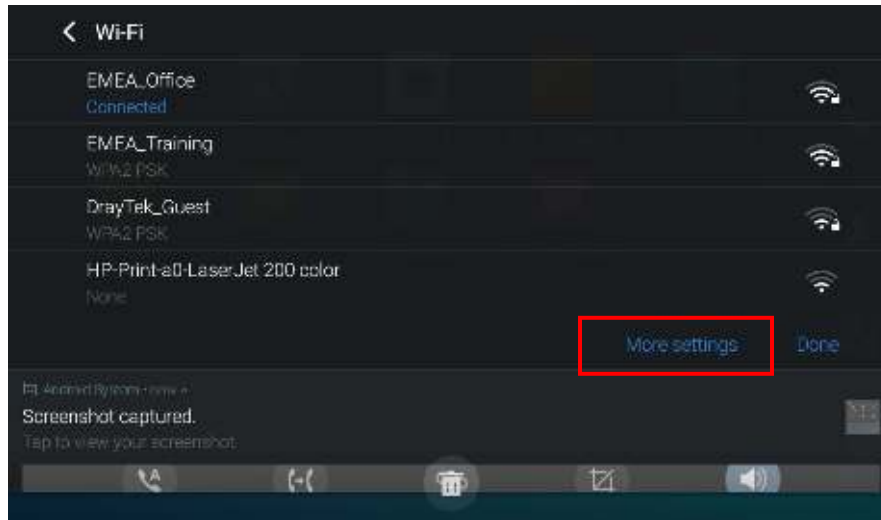

Figure 171: Wi-Fi Shortcut - Wi-Fi List

For more information about how to use Wi-Fi on the GXV3370, please refer to the link below:

http://www.grandstream.com/sites/default/files/Resources/gxv3275_wifi_guide_0.pdf

Bluetooth

Bluetooth is a proprietary, open wireless technology standard for exchanging data over short distances from fixed and mobile devices, creating personal area networks with high levels of security. The GXV3370 supports Bluetooth, version 4.0 + EDR. Users could use Bluetooth to transfer files, share contact information with other Bluetooth portable devices, use Bluetooth headset for making calls, switch calls to the GXV3370 from mobile devices using Bluetooth hands-free profile, and listen to media (music or other audio output) from the GXV3370.

To connect to a Bluetooth device, turn on GXV3370's Bluetooth radio first. The first time when using a new Bluetooth device with the GXV3370, "pair" the device with GXV3370 so that both devices know how to connect securely to each other. After that, users could simply connect to a paired device. Turn off Bluetooth if it is not used.

Bluetooth settings are under GXV3370's **Settings**→**Basic**→**Bluetooth**.

Turn On/Off Bluetooth

1. Go to GXV3370's **Settings** → **Basic** → **Bluetooth**.
2. Check or uncheck Bluetooth option.

Or users could open the top status bar→ tap on Bluetooth icon  to turn it on/off.

Change Bluetooth Device Name

The GXV3370 uses "GXV3370_XXXXXY" as Bluetooth device name by default where "XXXXXX" is the last 6 digits of the phone's MAC address and the "Y" is the last 6th digit plus 2. The device name will be visible to other devices when connecting them. Follow the steps below to change the name:

1. Go to GXV3370's **Settings**→**Basic**→**Bluetooth**
2. Turn on **Bluetooth**.
3. Select **Additional settings**.
4. Press "Device name".
5. Enter a name and tap on "Rename".

Pair GXV3370 with a Bluetooth Device

Before connecting GXV3370 with other Bluetooth device, users must pair them first. They will stay paired afterwards unless they are unpaired.

1. Go to GXV3370's **Settings** → **Basic** → **Bluetooth**
2. Turn on **Bluetooth**.
3. Tap **Additional settings** and select "Visible to nearby Bluetooth devices" to make the GXV3370 phone visible to all nearby Bluetooth devices.
4. The GXV3370 scans and displays the IDs of all available Bluetooth devices in range. If the device you would like to pair with does not show up in the list (available devices), ensure that the other device is turned on and set to be discoverable.
5. If the GXV3370 stops scanning before the other device is ready, press  button to scan again.
6. Once the Bluetooth device shows up in the result, tap on it to start pairing. Confirm the passkey in the prompted message (if any). Or if passcode is required, please refer to the device's documentation or other procedures to obtain the passcode.



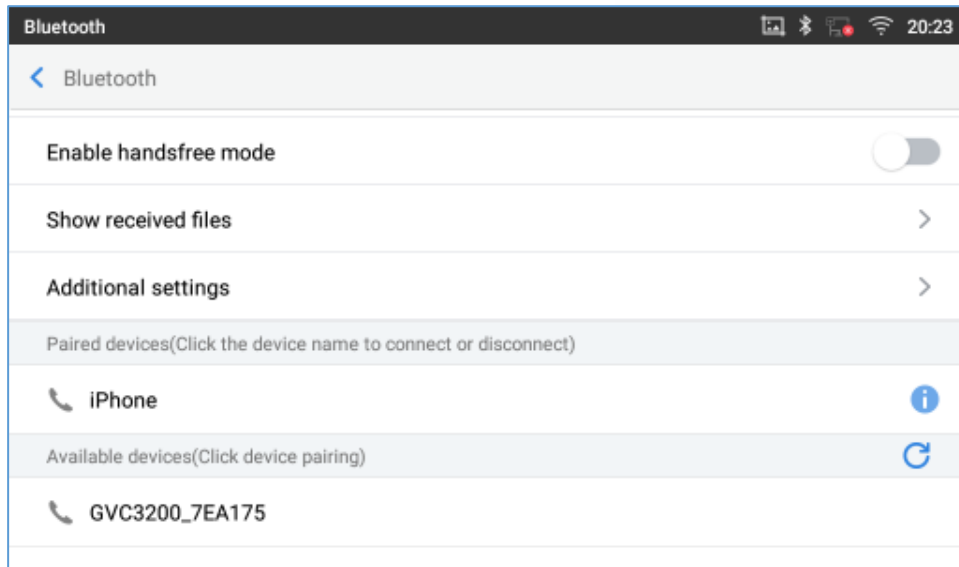



Figure 172: GXV3370 Bluetooth - Paired Device

Unpair a Bluetooth Device

1. In the Bluetooth settings, tap on  button corresponding to the Bluetooth device.
2. Select **Unpair**.

Bluetooth Settings Shortcut

User can enter the Bluetooth settings by sliding the Status Bar, then long Press on the Bluetooth icon.

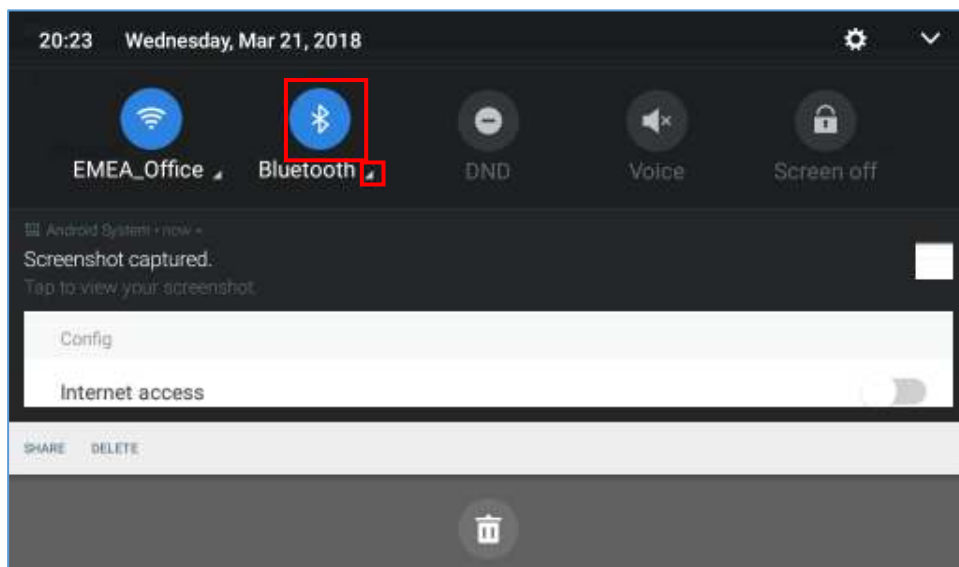

Figure 173: Bluetooth Settings Shortcut

-Or-

Press the letter under Bluetooth icon this will show the list of the paired devices. Press “More Settings” to access the Bluetooth settings.

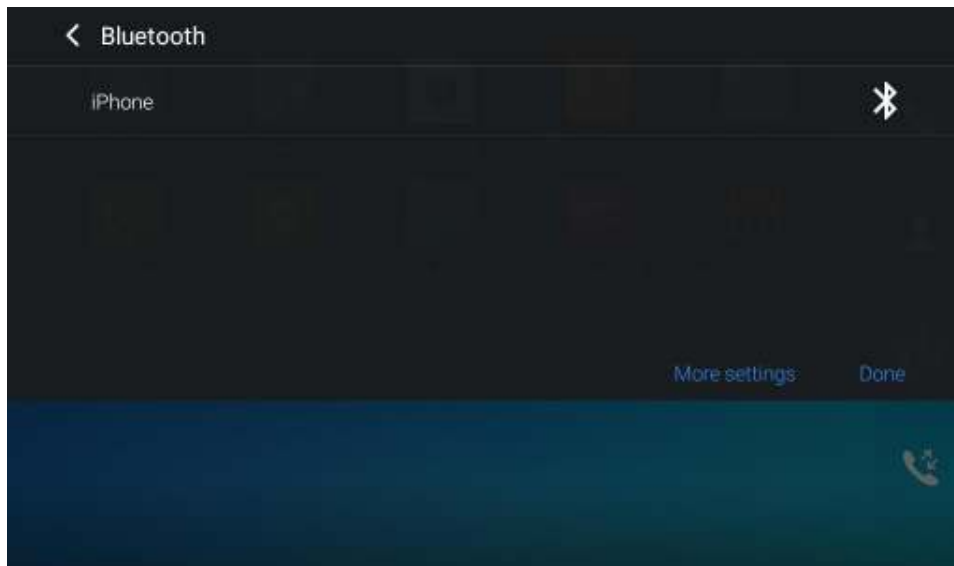

Figure 174: Bluetooth Setting shortcut 2

For more information about Bluetooth feature on the GXV3370, please refer to the link below:

http://www.grandstream.com/sites/default/files/Resources/gxv3275_bluetooth_guide_1.pdf

EHS Headset

The GXV3370 supports normal RJ9 headset and EHS headset. To use Plantronics EHS headset:

1. Go to the GXV3370 Home screen → **Settings** → **System** → **Peripherals**: enable option “Plug RJ9/EHS headset”
2. Connect EHS Headset to the GXV3370. Insert headset connector into the RJ9 headset port on the back of GXV3370.

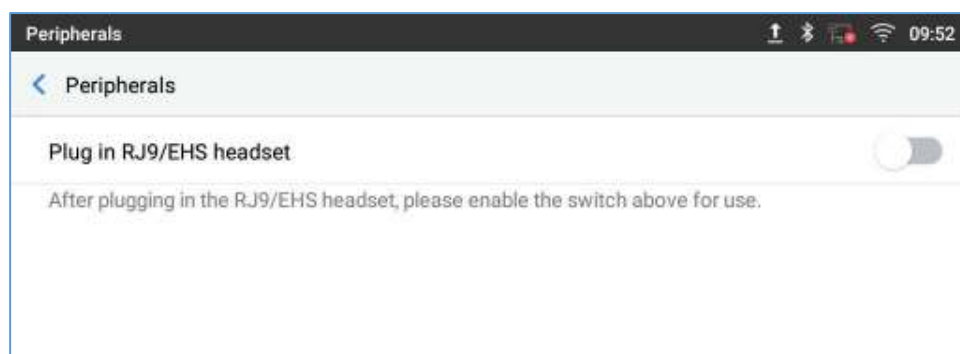

Figure 175: EHS headset

USB Headset

The GXV3370 supports the GUV3005/3000 headset. The GUV3000 and GUV3005 are HD USB Headsets that offer high-quality sound. Ideal for remote workers and busy environments, these USB headsets feature a noise cancellation microphone that minimizes background noise to provide crisp HD audio. The headset features multiple call control features such as answer/end a call, volume adjustment and mute/unmute. Users can plug in the USB port with the headset and simply use the headset as default media input/output channel. For more details, please visit: <http://grandstream.com/products/personal-collaboration-devices/headsets>

Once the USB headset plugged, it will be detected automatically, and the following icon will be shown on the top right of the status bar, this means a USB headset is connected.

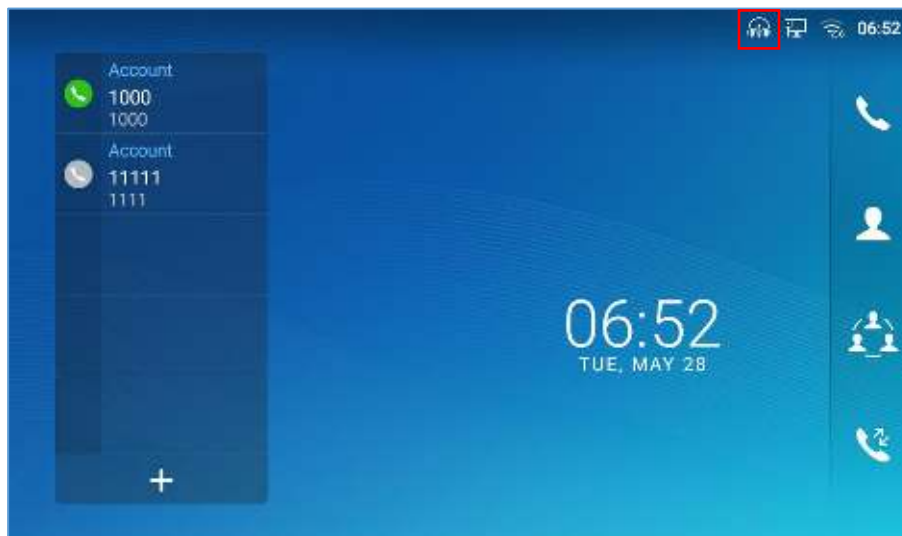

Figure 176: USB Headset Connected

In the calling screen, user can press on the USB headset button (shown in figure below) to enable USB headset. The status bar shows the icon modified indicating that the USB headset is being used for speaking.

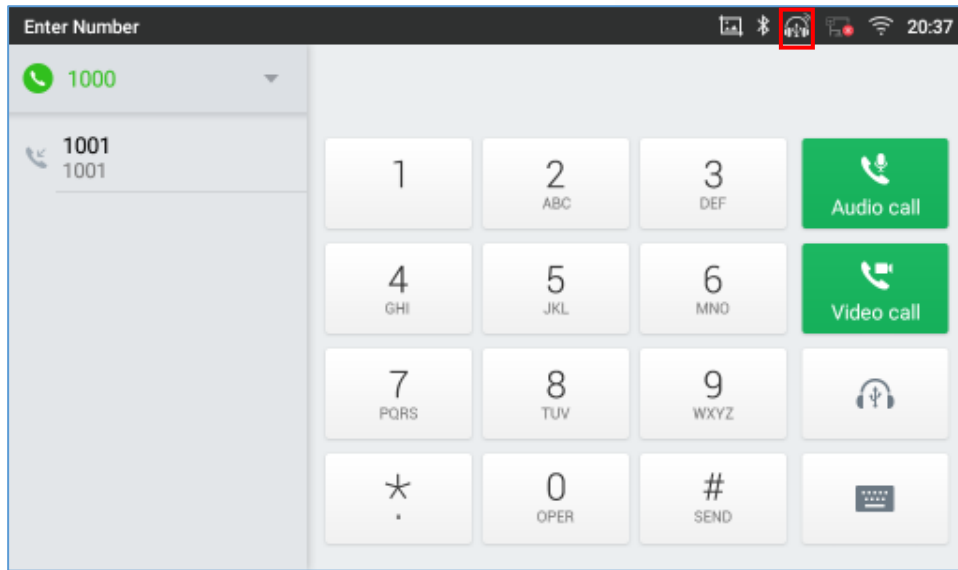

Figure 177: USB Headset Used for Call

During the call, users can tap on “More” then “Media Channel” to toggle between Handset Speaker and USB Headset.

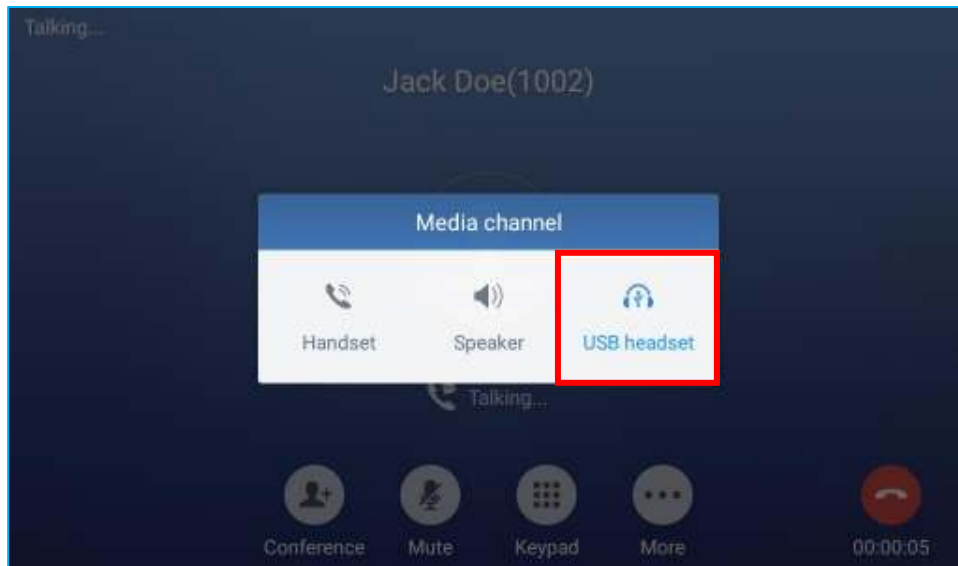



Figure 178: Switch Between Speaker and USB mode

USB

The GXV3370 supports USB connection with USB storage devices. To connect and access USB storage device:

1. Insert an USB storage device into USB port at the back of the GXV3370.
2. It will take a few seconds for the GXV3370 to prepare the connection. Then the USB storage icon  will show on the status bar.
3. To access USB storage, go to GXV3370 MENU→**File Manager** → **USB**. Tap on it to access and manage your data.

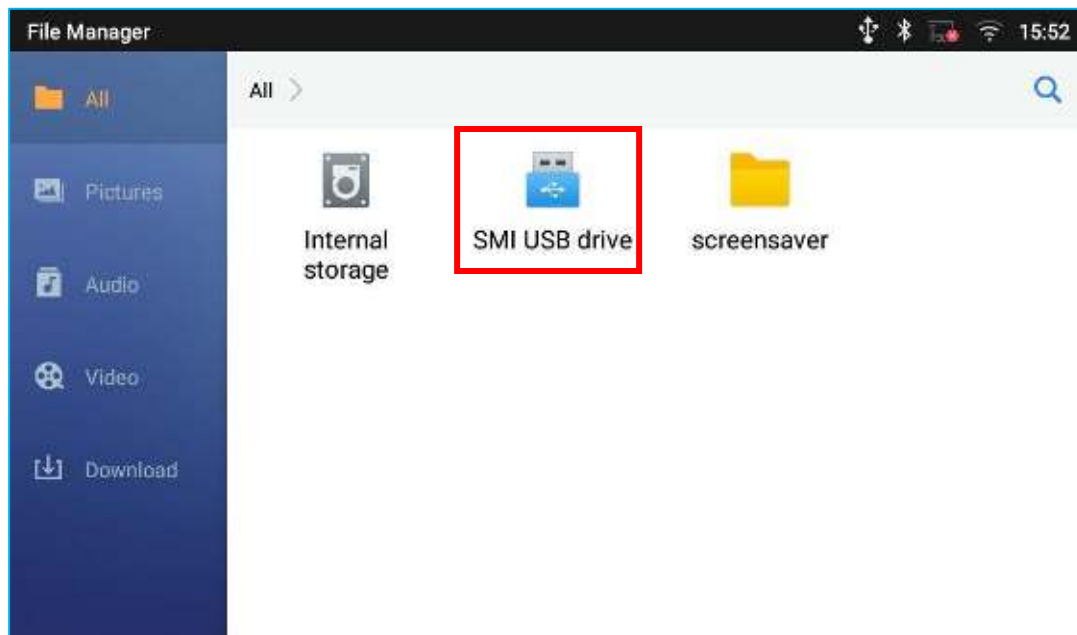



Figure 179: USB Storage Device Connected to GXV3370

SD Card

1. Insert your SD card into SD Card slot at the back of GXV3370. Please make sure the SD Card is inserted with right direction on the GXV3370 as indicated on the SD card slot.
2. It will take a few seconds for the GXV3370 to prepare the connection. Then the SD Card icon  will show on the status bar.
3. To access SD Card, go to GXV3370 MENU→**File Manager**→**SD card**. Tap on it to manage your data.

EMERGENCY CALL

Users could configure Emergency Call Numbers on **GXV3370 Web GUI →System Application→Contacts→General Settings**, in order to still being able to call those numbers even when the phone is locked. Emergency call interface can be accessed by tapping on “EMERGENCY” under the GXV3370 locked screen. Please, refer to the following figure:

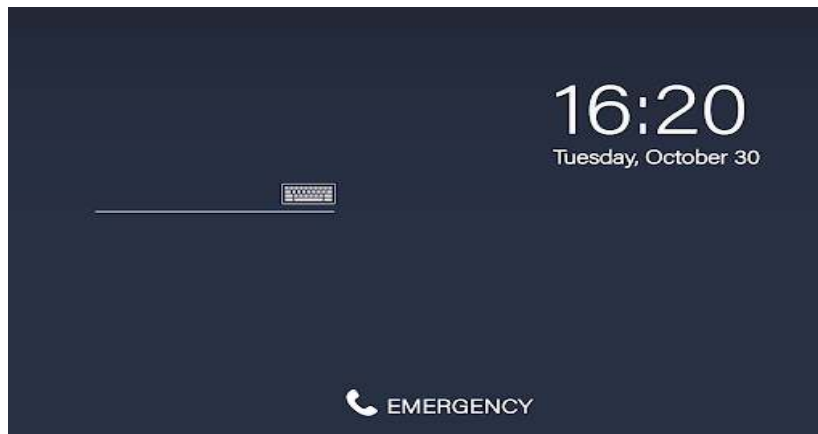

Figure 180: Emergency Access under GXV3370 Locked Screen

Once “EMERGENCY” is pressed, a dial screen will show, and users can choose the numbers allowed to be dialed from the list on the left of the dial screen.



Figure 181: Emergency Dial Screen

Note: The GXV3370 is not pre-configured to support or carry emergency calls to any type of hospital, law enforcement agency, medical care unit (“Emergency Service(s)”) or any other kind of Emergency Service. You must make additional arrangements to access Emergency Services. It is your responsibility to purchase SIP-compliant Internet telephone service, properly configure the GXV3370 to use that service, and periodically test your configuration to confirm that it works as you expect. If you do not do so, it is your responsibility to purchase traditional wireless or landline telephone services to access Emergency Services.

GXV3370 GUI CUSTOMIZATION TOOL

Users could customize the GUI desktop layout as well as GUI configurations on the GXV3370 by using “GXV3370 GUI Customization Tool” available through the link: <http://tools.grandstream.com:8081>

The tool offers users with flexibility and control and it includes displaying/hiding applications, configuring parameters on the phone with specific requirements, controlling the display appearance, enabling/disabling some functions and much more.

For more information about “GXV3370 GUI Customization Tool”, please refer to the following guide describing how to use the tool:

http://www.grandstream.com/sites/default/files/Resources/GXV3370_GUI_Customization_Web_Tool_Guide.pdf



EXPERIENCING THE GXV3370 APPLICATION PHONE

Please visit our website: <http://www.grandstream.com> to receive the most up- to-date updates on firmware releases, additional features, FAQs, documentation and news on new products.

We encourage you to browse our [product related documentation](#), [FAQs](#) and [User and Developer Forum](#) for answers to your general questions. If you have purchased our products through a Grandstream Certified Partner or Reseller, please contact them directly for immediate support.

Our technical support staff is trained and ready to answer all your questions. Contact a technical support member or [submit a trouble ticket online](#) to receive in-depth support.

Thank you again for purchasing Grandstream Enterprise Application phone, it will be sure to bring convenience and color to both your business and personal life.

*** Android is a trademark of Google LLC.**

*** Skype and Skype for Business are Registered Trademarks of Microsoft Corporation.**

© 2002-2014 OpenVPN Technologies, Inc.

OpenVPN is a registered trademark of OpenVPN Technologies, Inc.



HDMI, the HDMI Logo, and High-Definition Multimedia Interface are trademarks or registered trademarks of HDMI Licensing LLC in the United States and other countries.

