

Yealink ZVC Series Zoom Rooms Kit Deployment Guide



Contents

Introduction.....	5
Hardware Overview.....	5
MCore.....	5
UVC80.....	6
UVC50.....	7
UVC30 Room.....	8
CP960.....	8
MShare(Optional).....	9
Related Documentations.....	10
Technical Specifications.....	11
Deployment and Connection.....	12
ZVC800 Zoom Rooms Kit.....	13
ZVC500 Zoom Rooms Kit.....	14
ZVC300 Zoom Rooms Kit.....	15
Recommended Deployment Solution.....	15
Deployment Solutions of Different Meeting Rooms.....	15
Camera Installation.....	17
Recommendations of MCore Installation.....	19
Conference Room Wiring.....	19
Initial Setup.....	19
ZoomRooms Account.....	20
ZoomRoomsAdmin Account.....	20
Wireless Network Connection for CP960.....	20
Pairing the Zoom Rooms with CP960.....	20
Using CP960 as an Audio Input and Output Device.....	21
Using CP960 as Zoom Rooms Controller.....	24
Signing Into Your Zoom Rooms Account.....	24
Signing Out of Your Zoom Account from Your Phone.....	25
Basic Features on the Phone.....	25
Controlling UVC80/UVC50/UVC30 Camera.....	26
Setting the UVC80/UVC50/UVC30 as the Default Camera.....	26
Controlling UVC80/UVC50/UVC30 Room Camera Position.....	27
Creating the Preset Position for UVC30.....	27
Resetting the Preset Position for UVC30.....	28
Renaming the Preset Position for UVC30.....	28
Setting UVC30 Camera to Preset Position.....	28
Enabling/Disabling Auto-framing for UVC30.....	28

Content Sharing	29
Wired Content Sharing.....	29
Sharing Content with WPP20 Wireless Presentation Pod.....	29
Pairing the WPP20 with the MShare.....	29
Sharing Content via WPP20.....	29
Stopping Sharing Content via WPP20.....	30
Stopping Sharing Content.....	30
Using Hybrid Mode	30
Enabling the Hybrid Mode.....	31
Switching Between SIP Mode and Zoom Rooms Mode.....	31
Basic Settings on the Phone	31
Setting the Language.....	31
Setting the Input Method.....	32
Time and Date Display.....	32
Setting the Time and Date Manually.....	32
Changing the Time and Date Format.....	32
Changing the Screen Backlight Brightness and Time.....	33
Changing the Screen Saver Type and Waiting Time.....	33
Setting the Signal Port of Yealink Plugin.....	33
Using the CP Wireless Expansion Mic CPW90	34
Registering the CPW90.....	34
Unregistering the CPW90.....	34
Viewing CPW90 Information.....	35
Finding the CPW90.....	35
Switching Between ZoomRooms Account And ZoomRoomsAdmin Account	35
ZoomRoomsAdmin Sign-in.....	35
ZoomRooms Account Sign-in.....	35
Logging into Yealink Management Cloud Service/Yealink Device Management Platform	36
Troubleshooting	36
Upgrading System Software.....	37
Enabling Windows Update Service.....	37
Update the Devices.....	37
Upgrading the CP960.....	38
Accessing the Web User Interface.....	38
Update the Firmware Manually via Web User Interface.....	38
Firmware for Each Device.....	39
Checking Whether the Phone Can Access to the External Network.....	39
General Issues.....	40
Any Anti-virus Software Needed to Be Installed on the MCore?.....	40

The display does not display the shared content.....40

Introduction

The Yealink ZVC series of video solution is designed for immersive (intelligent) Zoom meetings in various sizes meeting rooms. The ZVC series is a bundle video solution that includes everything you need to seamlessly and smartly meet, connect, and collaborate with internal and external users. The ZVC series delivers premium audio and video quality thanks to its Yealink audio devices and UVC series of optical PTZ cameras. Featuring Yealink HD audio and Noise Proof technology, everyone's voice in the room can be heard clearly. In addition, Yealink's complete solution provides users with a flexible deployment that adapts to your specific room layout. This solution gives organizations a native and easy Zoom Rooms meeting experience.

UVC80 is a 12x optical zoom PTZ camera, supports 1080P/60FPS video calls to make your business discussion be as life-like and interactive as possible. CP960 is uniting microphones, speaker, and meeting console all in one. All combine to make ZVC800 Zoom Rooms one of the perfect solutions for the medium and large meeting rooms.

UVC50 is a 5x optical zoom PTZ camera, supports 1080P/60FPS video calls to make your business discussion be as life-like and interactive as possible. CP960 is uniting microphones, speaker, and meeting console all in one. All combine to make ZVC500 Zoom Rooms one of the perfect solutions for the small and medium meeting rooms.

The Yealink ZVC300 Zoom Rooms includes a UVC30 ultra HD 4K camera with auto framing feature and CP960 uniting microphones, speaker, and meeting console all in one. ZVC300 Zoom Rooms is a perfect suit for the huddle and small meeting room.

The Zoom Rooms system also supports connecting to the Yealink Management Cloud Service or Yealink Device Management Platform for unified management, as well as diagnosis and alarm for all devices in the Zoom Rooms system.

- [Hardware Overview](#)
- [Related Documentations](#)
- [Technical Specifications](#)

Hardware Overview

This chapt provides an overview of hardware.

- [MCore](#)
- [UVC80](#)
- [UVC50](#)
- [UVC30 Room](#)
- [CP960](#)
- [MShare\(Optional\)](#)

MCore

The following describes the corresponding ports of MCore:

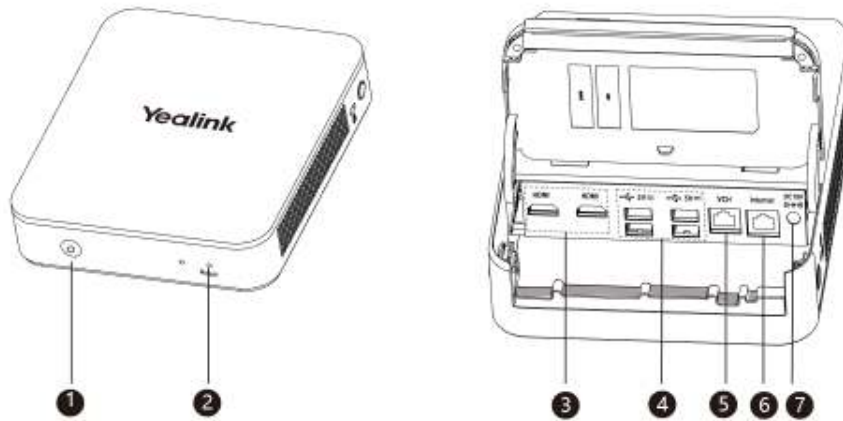

	Port Name	Description
①	Power	Powers on or powers off.
②	Reset Key	Reset the MCore to factory defaults.
③	HDMI	Connects to a display.
④	USB 3.0 Port	<ul style="list-style-type: none"> Connects to the UVC80/UVC50/UVC30 Room. Connects to a wireless USB dongle to use the wireless keyboard or the mouse. Connects to other USB devices.
⑤	VCH port	/
⑥	Internet	Connects to the network device.
⑦	DC19V	Connects to the power adapter.

UVC80

The following describes the corresponding ports of UVC80:

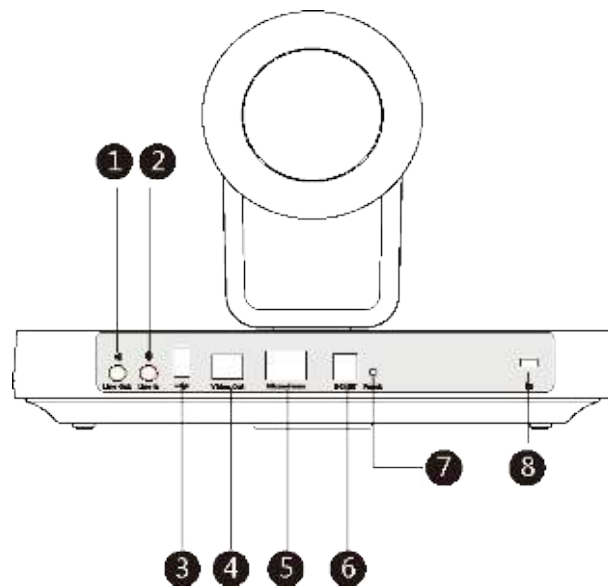

	Port Name	Description
①	Line Out	Connects to an audio output device using a 3.5mm audio cable, for example MSpeaker II.
②	Line In	Connects to an audio input device using a 3.5mm audio cable.
③	USB(Optional)	/
④	Video Out	Connects to a PC as a video output.
⑤	Microphone	Connects to a microphone.
⑥	DC48V	Connects to the power adapter.
⑦	Reset	Resets the UVC80 to factory defaults.
⑧	Security Slot	Creates a secure connection to the UVC80 with a universal security cable to lock UVC80 down.

UVC50

The following describes the corresponding ports of UVC50:

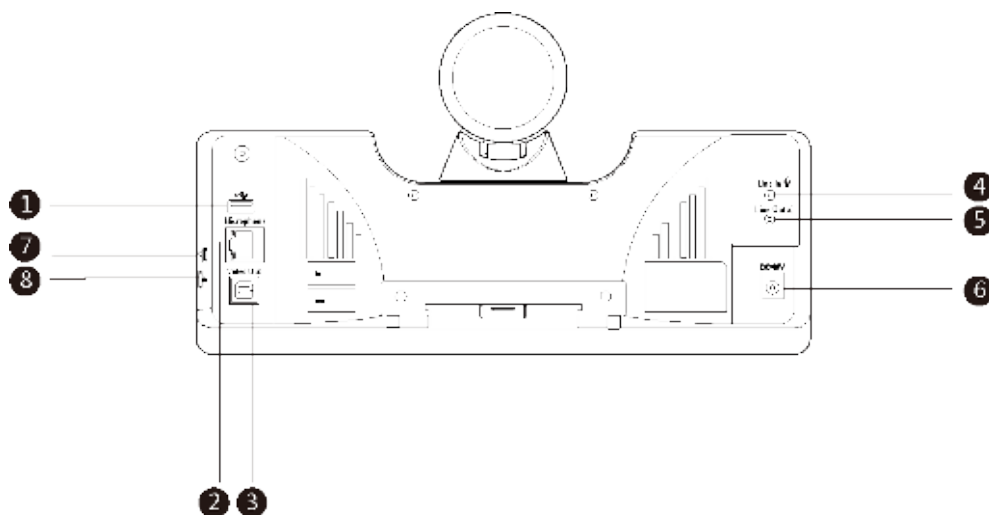

	Port Name	Description
①	USB(Optional)	/
②	Microphone	Connects to a microphone.
③	Video Out	Connects to a PC as a video output.
④	Line In	Connects to an audio input device using a 3.5mm audio cable.
⑤	Line Out	Connects to an audio output device using a 3.5mm audio cable, for example MSpeaker II.
⑥	DC48V	Connects to the power adapter.
⑦	Reset	Resets the UVC50 to factory defaults.
⑧	Security slot	Creates a secure connection to the UVC50 with a universal security cable to lock UVC50 down.

UVC30 Room

The UVC30 Room is directly connected to the MCore via USB cable.

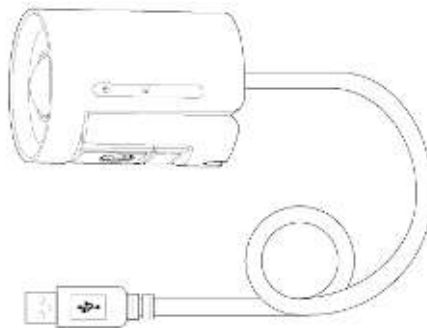

CP960

The following describes the hardware of CP960:

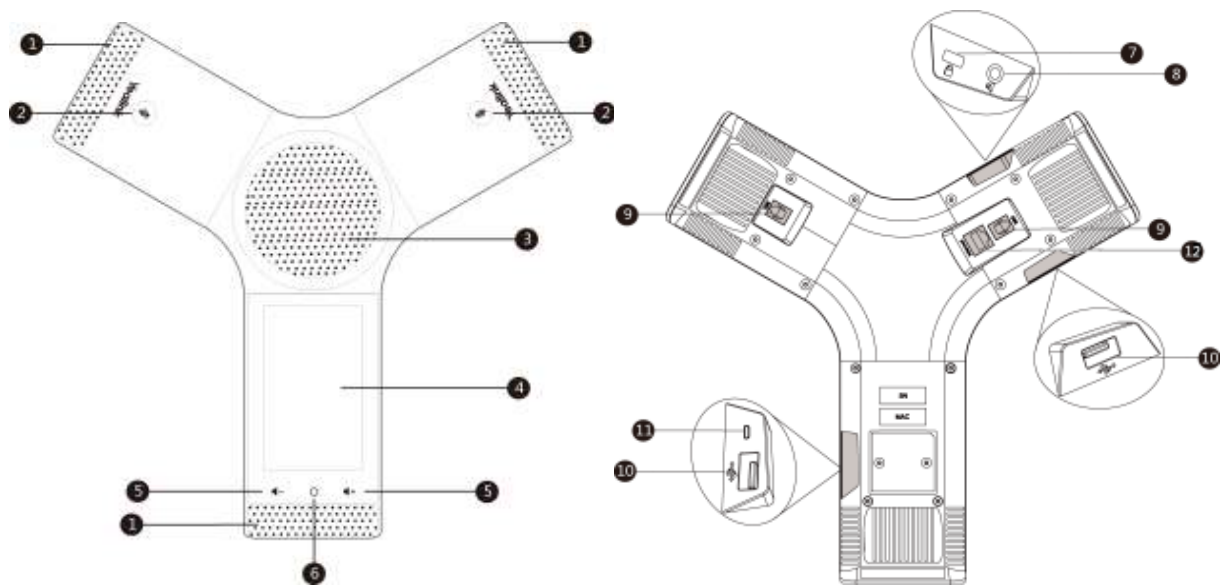

	Item	Description
1	Three Internal Microphones	Provide 20-foot and 360-degree coverage to transmit sound to other phones.
2	Mute Touch Keys	Toggle mute feature.
3	Speaker	Provides hands-free (speakerphone) audio output.
4	Touch Screen	Allows you to select items and navigate menus on the touch-sensitive screen. Tap to select items and navigate menus.
5	Volume Touch Keys	Adjust the volume of the speaker or the ringer.
6	HOME Touch Key	Tap it to return to the idle screen.
7	Security Slot	Enables you to attach a universal security cable lock to your phone so you can secure it to a desktop.
8	3.5mm Audio-out Port	Enables you to connect an optional external speaker.
9	Wired Mic Ports	Comes ready for the future connection of CPE90 wired expansion microphones.
10	USB Ports	CPW90 charging cradle.
11	Micro USB Port	Comes ready for the future PC connection that your phone will work as an external speaker and a microphone for your PC.
12	Network Port	Enables you to connect the phone to wired network.

MShare(Optional)

The following describes the corresponding ports of MShare:

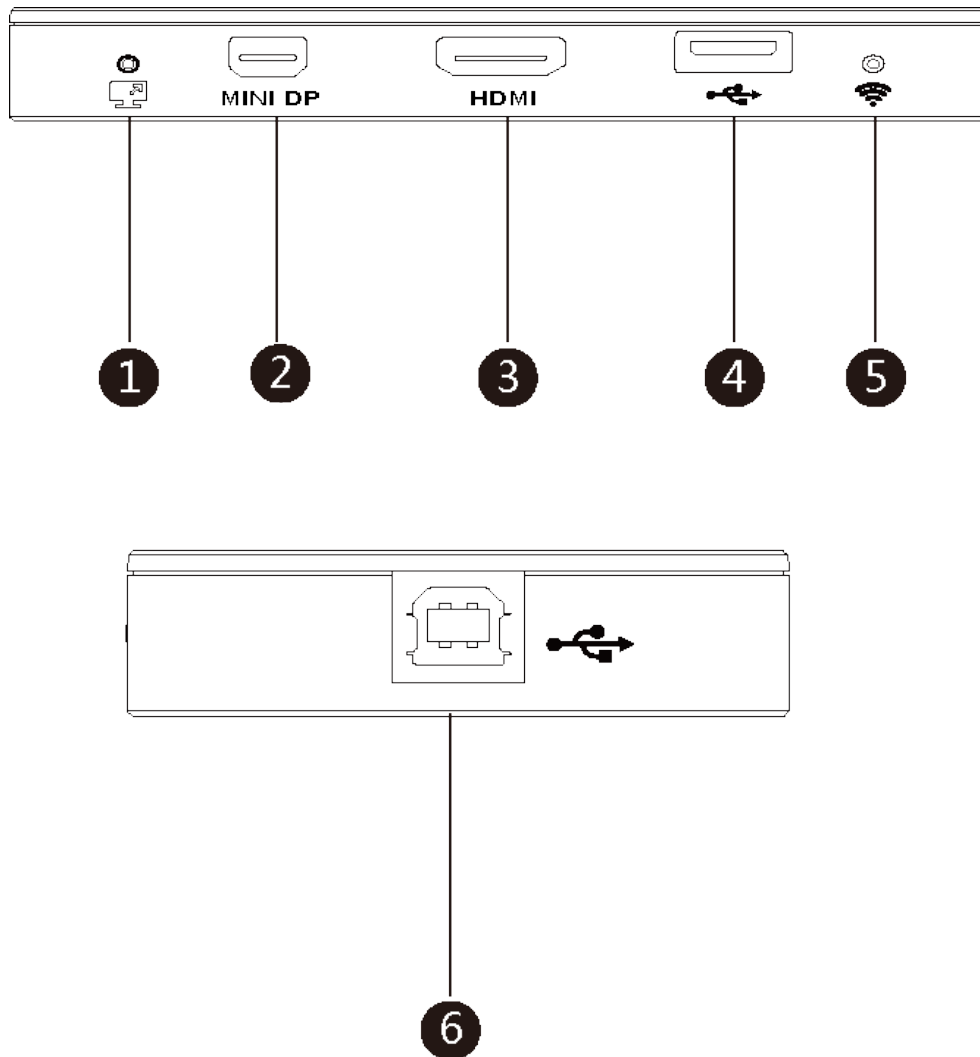

	Port Name/Indicator Name	Description
①	LED Indicator	Indicates the working status of MShare.
②	Mini DP	Connects to PC to share contents.
③	HDMI	Connects to PC to share contents.
④	USB	Connects to WPP20 to pair the WPP20 with the MShare.
⑤	Wi-Fi AP LED Indicator	Indicates the status of MShare connected to the WPP20.
⑥	USB	Connects to MCore.

Related Documentations

The following related documents are available:

- [Yealink ZVC Series Zoom Rooms Kit Quick Start Guide \(EN, CN\)](#)
- [Yealink UVC80 Quick Start Guide\(EN&CN\)](#)
- [Yealink UVC50 Quick Start Guide\(EN&CN\)](#)
- [Yealink UVC30 Room Quick Start Guide\(EN&CN\)](#)

- [Yealink MShare Quick Start Guide\(EN&CN\)](#)
- [Yealink MCore Quick Start Guide \(EN, CN\)](#)

Technical Specifications

Operating System	Windows 10 IoT Enterprise
Software	Zoom Rooms
Processor / SSD / RAM	8th Gen Intel® QUAD-Core™ i5/128GB/8GB (2 x 4GB)
Ports	<ul style="list-style-type: none"> • 2 x HDMI video output • Bluetooth and Wi-Fi • 1x Yealink VCH port, for connecting MTouch II • 4 x USB3.0 Type-A • 1 x 10/100/1000M Ethernet port • 1 x Power port • Built-in cable management
Buttons	Power On button on the front
UVC80	<ul style="list-style-type: none"> • 1920 x 1080 video resolution • 60 frame rate • 12x optical zoom • Field of view (diagonal): 78.5° • Pan angle range: 200° • Tilt angle range: 60°
UVC50	<ul style="list-style-type: none"> • 1920 x 1080 video resolution • 60 frame rate • 5x optical zoom • Field of view (diagonal): 91° • Pan range: 60° • Tilt range: 40°
UVC30 Room	<ul style="list-style-type: none"> • 4K video resolution • Maximum 60FPS • 3x digital zoom • Field of view (diagonal): 120° • Facial detection and Auto framing • 1 x 3m USB 2.0 cable
MShare	<ul style="list-style-type: none"> • 1080P/30FPS FHD • Support wired and wireless content sharing • Built-in Wi-Fi AP for Yealink wireless presentation device

CP960	<ul style="list-style-type: none">• Optimal HD audio• 20-foot (6-meter) microphone pickup range• Built-in 3-microphone array, 360-degree voice pickup• 5" 720x1280 capacitive touch screen• Full-duplex technology• Noise suppression (NS)
--------------	---

Deployment and Connection

The following contents describe the deployment and connection of Yealink Solution for Zoom Rooms, which consists of CP960, UVC80/UVC50/UVC30 camera, and MCore.

The CP960 with Zoom Rooms version, can communicate with the MCore connected to the same LAN and can be used as Zoom Rooms controller, speaker, and microphone.

Yealink Plugin for Zoom Rooms and Zoom Rooms app have been installed on the MCore.

And the UVC80/UVC50/UVC30 camera is Plug-and-play. Make sure your phone and MCore can access the Internet.



Note: Make sure the display device is connected first. When starting up the system for the first time, you need to connect a mouse to complete the initial configuration. We recommend using the wireless mouse kit.

- [ZVC800 Zoom Rooms Kit](#)
- [ZVC500 Zoom Rooms Kit](#)
- [ZVC300 Zoom Rooms Kit](#)
- [Recommended Deployment Solution](#)

ZVC80 Zoom Rooms Kit

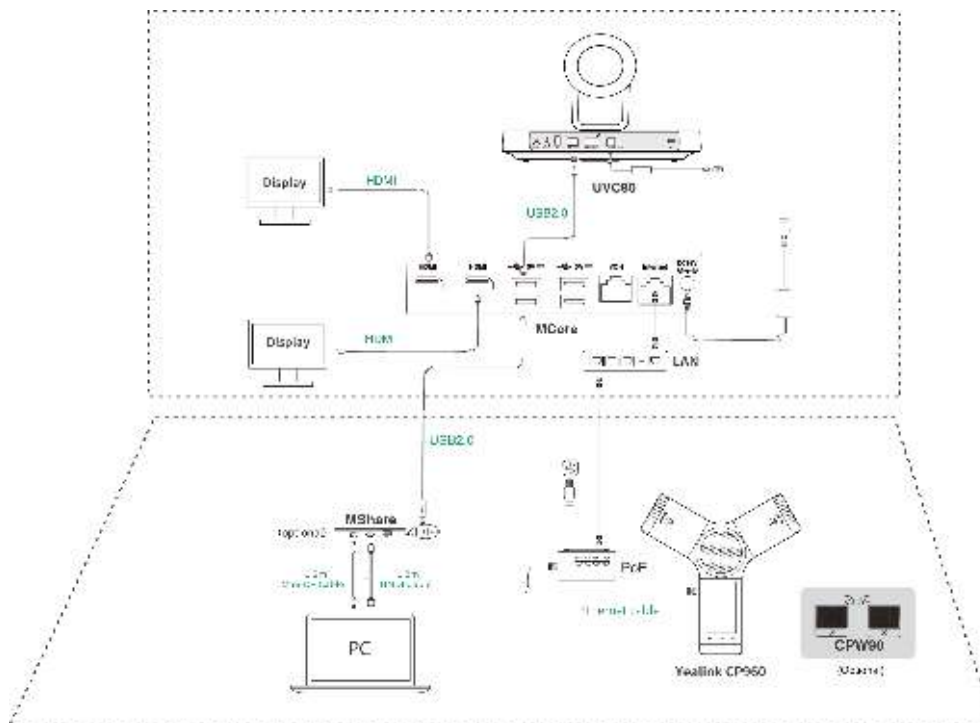

Note: For more information about the installation and deployment of accessories (for example, the installation of MCore or UVC80 camera), refer to the Quick Start Guide of the corresponding accessory.

ZVC500 Zoom Rooms Kit

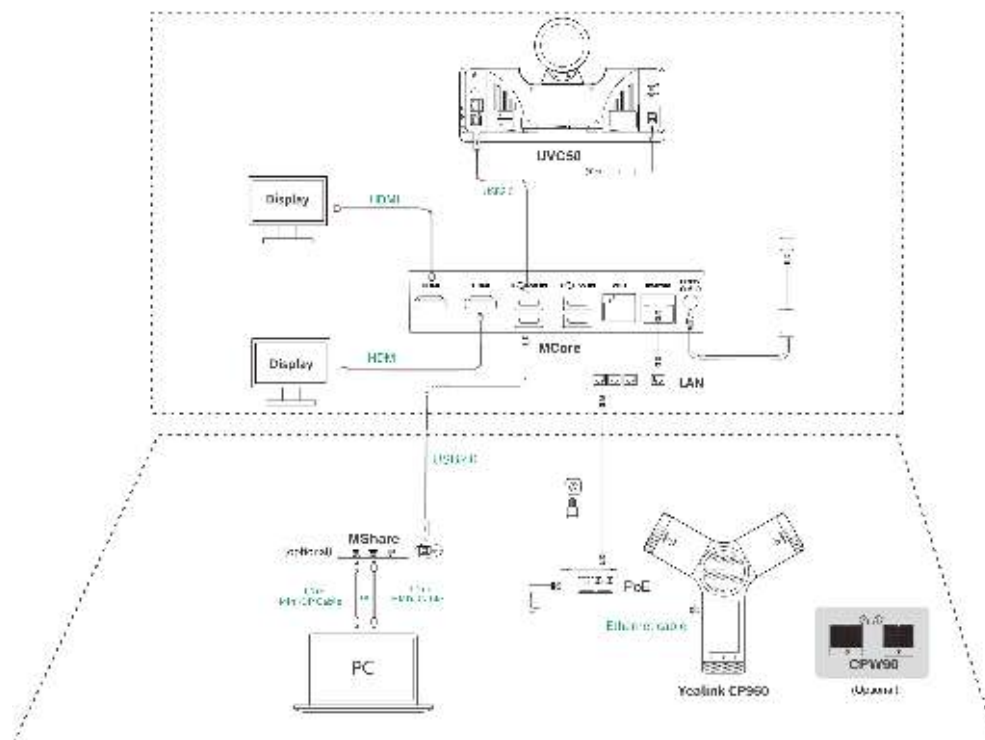

Note: For more information about the installation and deployment of accessories (for example, the installation of MCore or UVC50 camera), refer to the Quick Start Guide of the corresponding accessory.

ZVC300 Zoom Rooms Kit

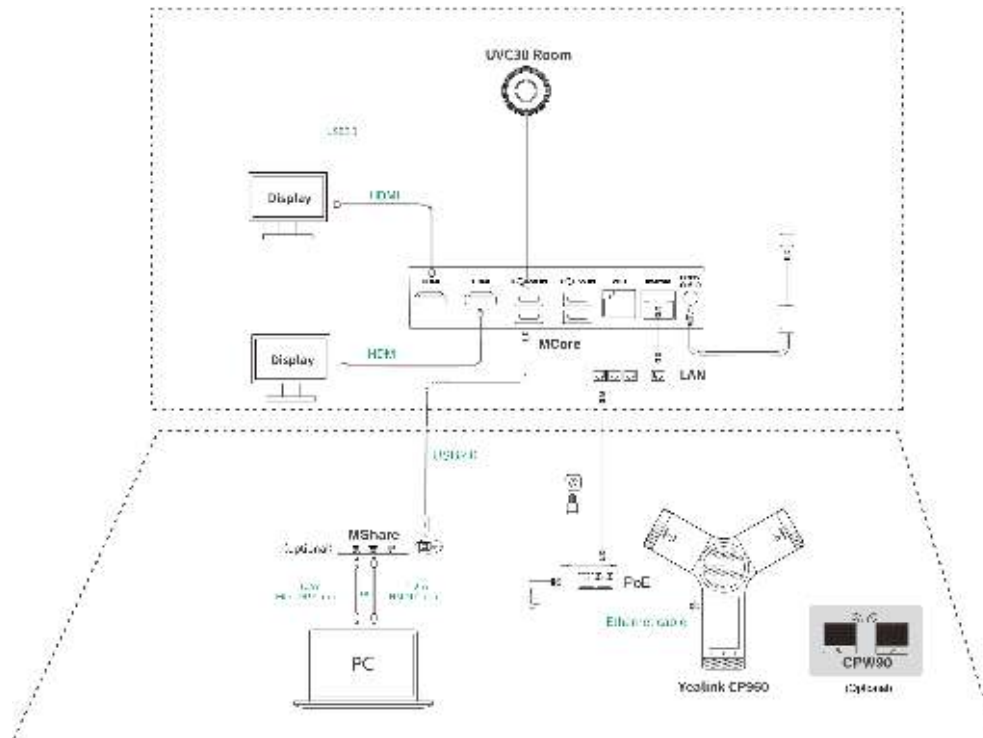



Note: For more information about the installation and deployment of accessories (for example, the installation of MCore or UVC30 camera), refer to the Quick Start Guide of the corresponding accessory.

Recommended Deployment Solution

- [Deployment Solutions of Different Meeting Rooms](#)
- [Camera Installation](#)
- [Recommendations of MCore Installation](#)
- [Conference Room Wiring](#)

Deployment Solutions of Different Meeting Rooms

Yealink ZVC Zoom Rooms system supports different camera devices (UVC80/UVC50/UVC30 Room) according to the conference requirements. Deployment solutions for different camera devices are as follows:

Medium-to-large room (8-18 People)	Small-to-medium meeting room (5-11 People)	Focus and small room(2-7 People) (2-7 People)
ZVC800 Zoom Rooms Kit	ZVC500 Zoom Rooms Kit	ZVC300 Zoom Rooms Kit
		

For Focus and small room(2-7 People)

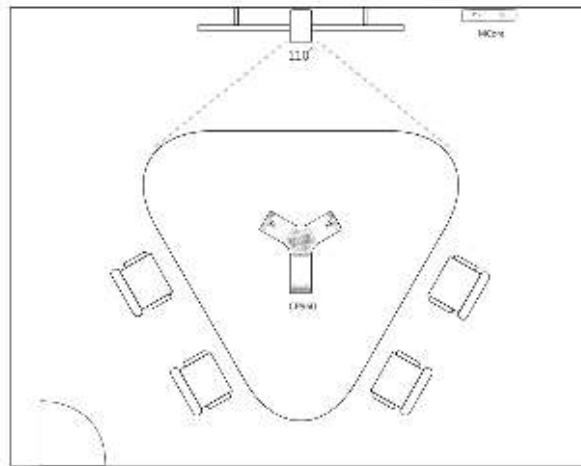

For Small conference room (5-11 people)

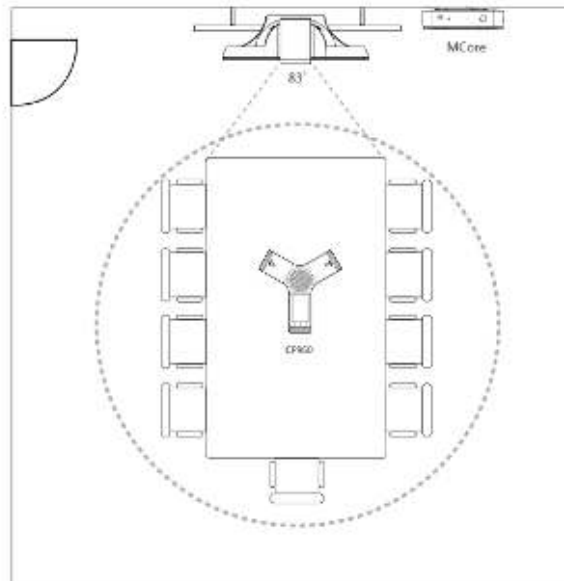

For Medium-to-large conference room (8-18 people)

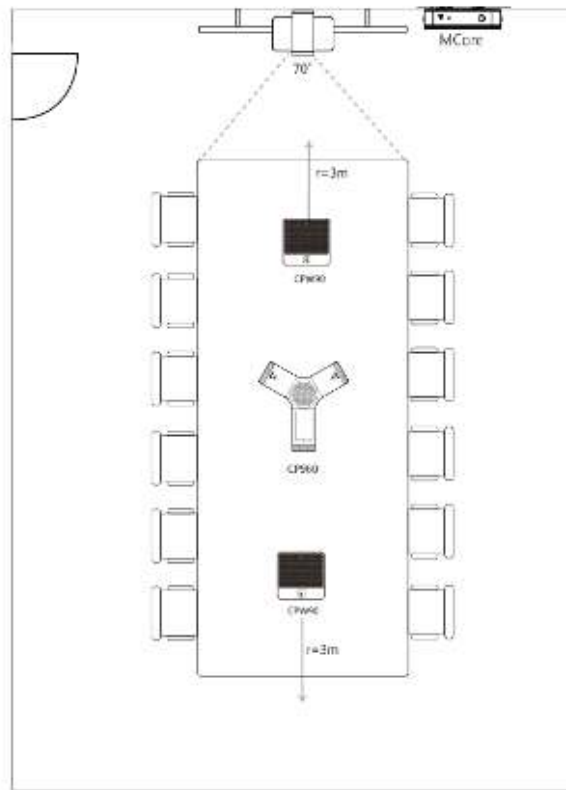

- CPW90 wireless microphones support 360-degree audio pickup at a radius of up to 3 meters.
- Place the CPW90 wireless microphones on a stable surface and keep them away from obstacles, so that they can pick up sounds effectively.

Camera Installation

You can mount the UVC80/UVC50 on the top of the TV, on the wall, on the ceiling, or onto a TV Stand or a Tripod.

You can mount the UVC30 on the top of the TV, on the wall, or onto a TV Stand or a Tripod.

The installation methods are as follows:

For UVC80:

Mount on Top of a TV



Mount on the Wall



Mount on the Ceiling

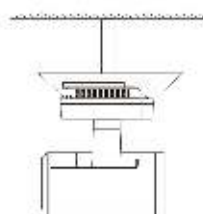

Mount onto a TV Stand or a Tripod

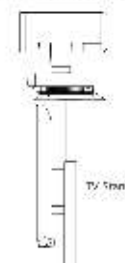

For UVC50:

Mount on the Top of the TV

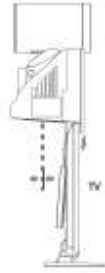

Mount on the Wall



Mount on the Ceiling

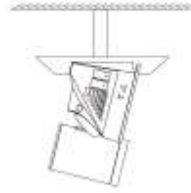

Mount onto a TV Stand or a Tripod

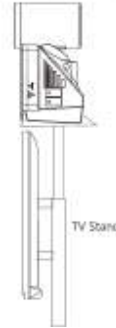

For UVC30:

Mount on Top of a TV



Mount on a Wall

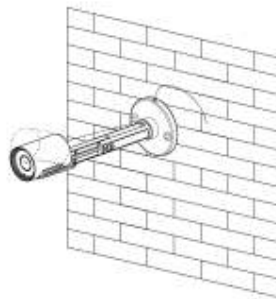

Mount onto a TV Stand or a Tripod

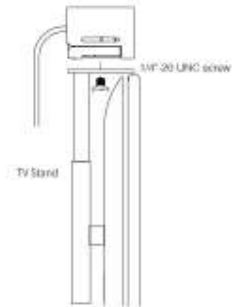

- [Recommendations of Camera Installation](#)

Recommendations of Camera Installation

The following is an example of installing UVC80:

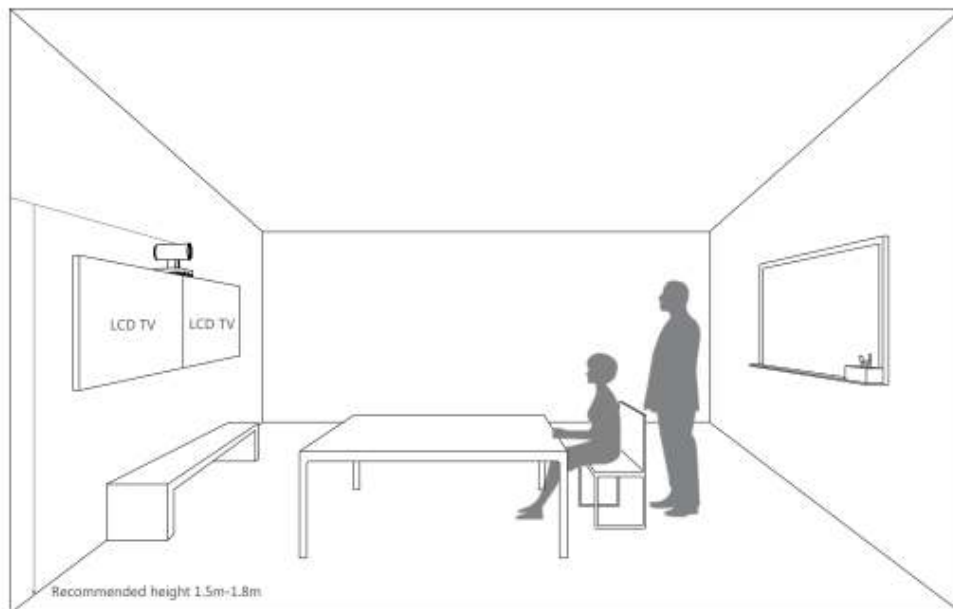

- Install the LCD TV and video camera relative to the center of the participants. Ensure that the participants face the camera and LCD TV directly during calls.
- The camera should be mounted on the wall, about 1.5 m to 1.8 m above the ground. Install the LCD TV below the camera.

- The camera should not face the light source directly, to prevent bad experience caused by dazzling light.

Recommendations of MCore Installation

You can mount the MCore on the wall near the TV, or stick it to the table or the backside of the TV cart.

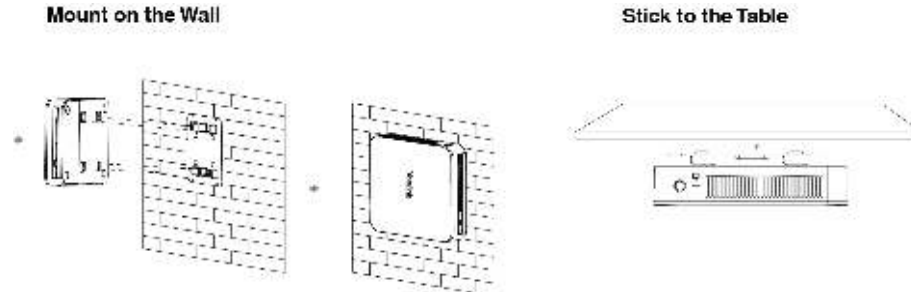

For more information on how to install the MCore, please refer to [Yealink Mcore Quick Start Guide \(EN,CN\)](#).

Conference Room Wiring

If the conference room has a dedicated routing channel, you can follow the way as it is. If not, follow the way below to route and fix the wire.

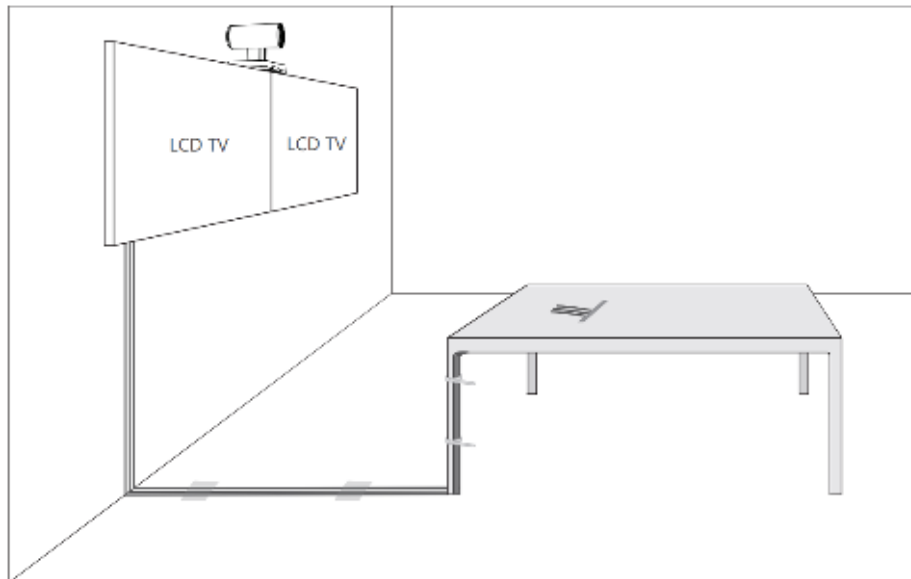

Note: If you require longer cable length for connecting the camera, you can use the USB extension cables for wiring.

Initial Setup

Once the MCore is powered on, the MCore will load the Microsoft Windows 10 IoT Enterprise operating system. By default, there are two Windows accounts (ZoomRooms account and ZoomRoomsAdmin account) built into the Zoom Rooms system. After the initial setup, the Zoom Rooms system is automatically run with the ZoomRooms account.



Note: Starting the MCore for the first time may take a long time to configure the Windows system and we recommend using the wireless mouse and keyboard to complete the Windows configuration.

- [ZoomRooms Account](#)
- [ZoomRoomsAdmin Account](#)

ZoomRooms Account

ZoomRooms account is the default account from which the Zoom Rooms app runs. This account is limited to running the Zoom Rooms app. The default password is “zoom123” without quotes. No administrator privileges are available from this account. The default account to run the Zoom Rooms Room is “ZoomRooms”, and this account will be automatically signed in when the system boots.

ZoomRoomsAdmin Account

The administrator user account is privileged, meaning you can perform any action on the system, with minimal restriction(usually requiring a password for confirmation). The default password is “zoom123” without quotes. The admin account is only used for device management, such as upgrading devices. For daily use such as Zoom Rooms meetings, the administrator credentials are not needed.

Related information

[Upgrading System Software](#)

Wireless Network Connection for CP960

Before you begin

Ensure that the CP960 and MCore are connected to the same LAN.

Procedure

1. Swipe down from the top of the screen to enter the device setting screen.
2. Tap **Settings** > **Basic Settings** > **Wi-Fi**.
3. Turn **Wi-Fi** on.
The phone will automatically search for available wireless networks in your area.
4. Tap an available wireless network from the list of networks.
5. If the network is secure, enter its password in the **Password** field and then tap **Connect**.

Pairing the Zoom Rooms with CP960

Before using CP960 as the Zoom Rooms controller, you need to pair the CP960 (preload the Zoom Rooms Controller) with the MCore (preload the Zoom Rooms app).

Before you begin

Ensure that the plugin is in operation.

Procedure

1. After the MCore is powered on, the **Zoom Rooms** app will be started automatically.
The pairing code will be displayed on the screen. Otherwise, you need to open the **Zoom Rooms** app manually.
2. Enter the pairing code on the touch screen of the CP960.
Then the CP960 (Zoom Rooms Controller) is paired with the MCore (Zoom Rooms app) successfully.

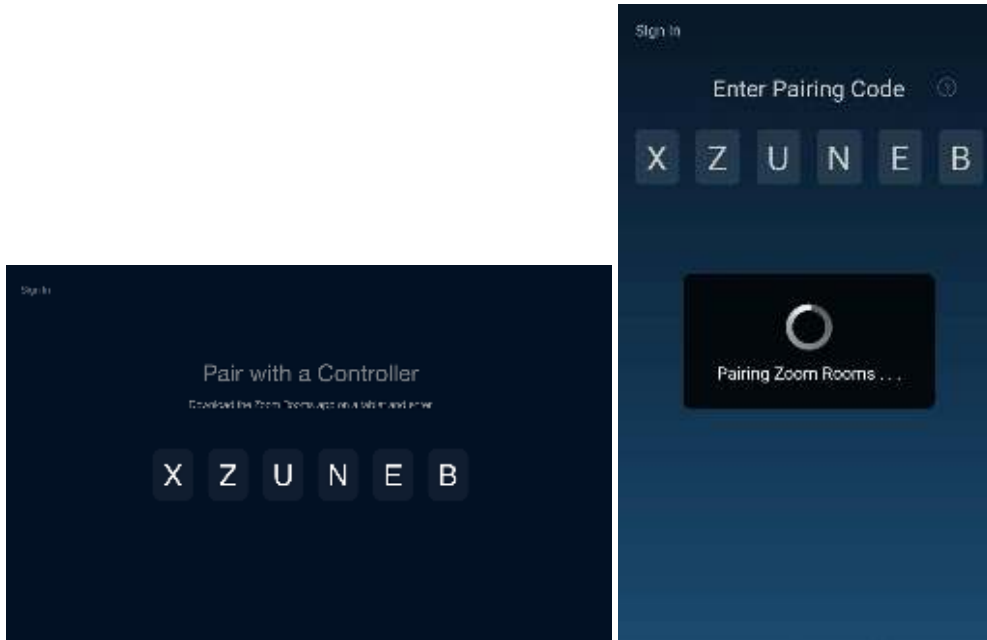

Using CP960 as an Audio Input and Output Device

After your phone is paired with MCore, it can be used as a default audio input and output device for the system.

Procedure

1. Tap  on the touch screen.
2. Disable **Lock Settings**.
You need to enter the room password to change the setting.

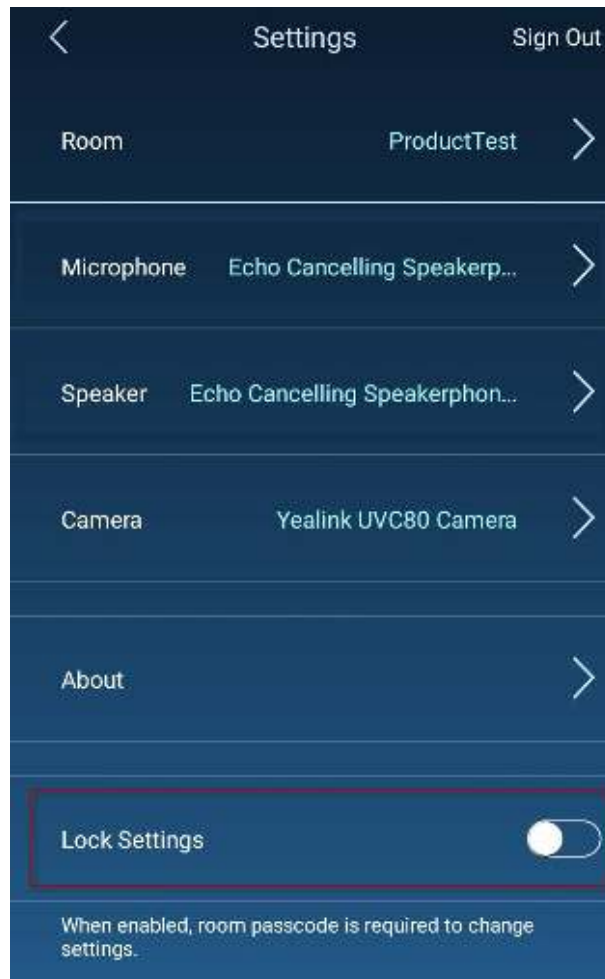

3. Tap the **Microphone** field and then select **Echo Cancelling Speakerphone (Yealink CP960 Speakerphone)** as your audio input device from the **SOURCE** field.

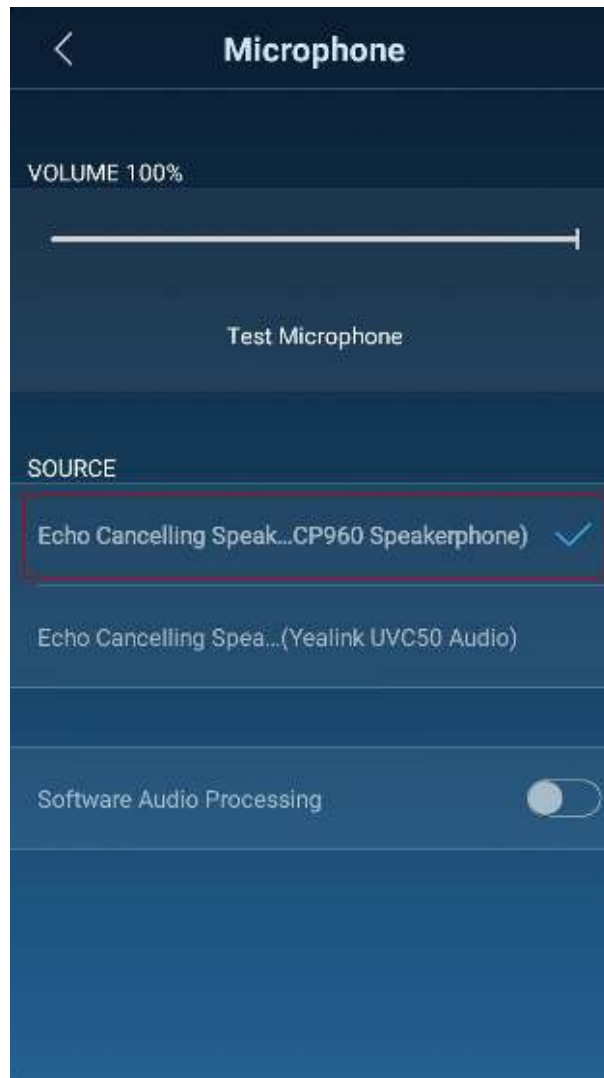

4. Tap the **Speaker** field and then select **Echo Cancelling Speakerphone (Yealink CP960 Speakerphone)** as your audio output device from the **SOURCE** field.

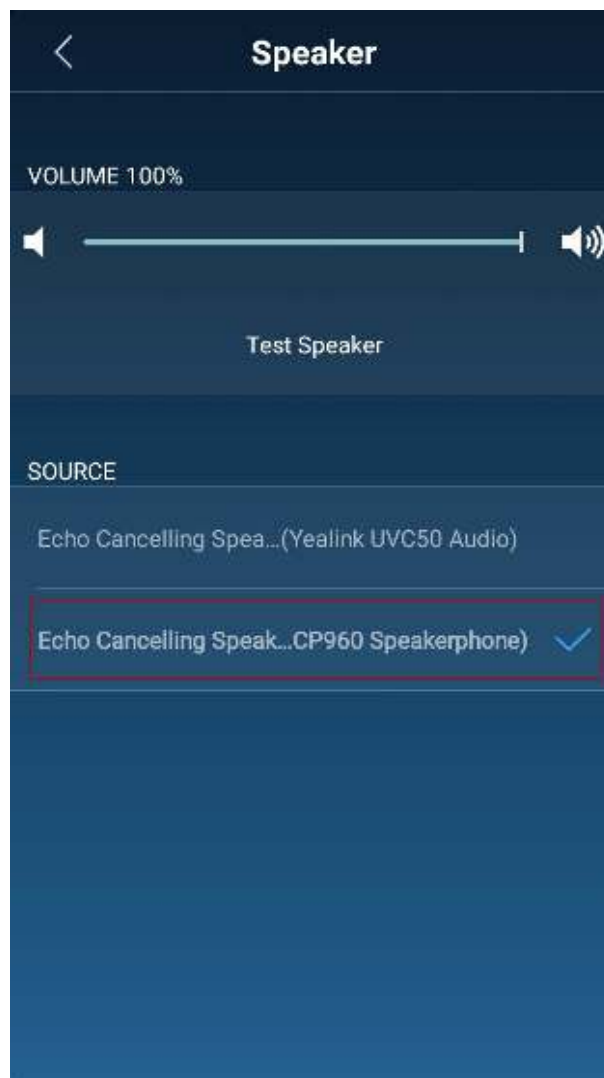

Using CP960 as Zoom Rooms Controller

After your phone is paired with theMCore, it can be used as a Zoom Rooms controller.

- [Signing Into Your Zoom Rooms Account](#)
- [Signing Out of Your Zoom Account from Your Phone](#)
- [Basic Features on the Phone](#)
- [Controlling UVC80/UVC50/UVC30 Camera](#)

Signing Into Your Zoom Rooms Account

Procedure

1. Tap **Sign In** on the touch screen.
2. Enter the email and password.
3. Tap **Sign In**.
The account is signed into the Zoom Room app synchronously.

Signing Out of Your Zoom Account from Your Phone

Procedure

1. Tap  > **Sign Out** on the touch screen.
2. Enter the room password to sign out.
3. Tap **OK**.



If you have disabled the **Lock Settings** before, the account will be signed out directly once you tap **Sign Out**.

Basic Features on the Phone

After you sign into an account on your phone, more features are available on the phone.



- **Meet Now:** Tap **Meet Now** to create an instant meeting.
- **Join:** Tap **Join** to join a meeting by entering the meeting ID or personal link name.

- **Phone:** Tap **Phone** to place a call.
- **Presentation:** Tap **Presentation** to start a presentation.
- : Tap  to check the status of the connected microphone, speaker and camera, and configure basic settings.

You can also view the Controller version, Zoom Rooms version and Controller IP at the path of  > **About** .

- **In-Meeting Controls, you can do the following:**
 - Mute/Unmute microphones in the room
 - Show/Hide local video
 - Share content or camera
 - Camera control
 - Change video layout (choose Thumbnail, Gallery, or Active Speaker)
 - View and manage meeting participants
 - Invite other participants to the meeting
 - Device Settings (Set the microphone, speaker and camera)
 - Leave the meeting or end the meeting if host
 - Control the meeting volume

For more information on specific features, please refer to [Zoom Rooms Controller Features](#).

Controlling UVC80/UVC50/UVC30 Camera

Zoom Rooms supports basic PTZ control for your UVC80/UVC50/UVC30 camera during meeting after setting the UVC80/UVC50/UVC30 camera as the default camera. In addition, the UVC30 also supports camera presets and auto-framing feature.



Note: The Yealink RoomConnect plug-in running under Windows supports advanced settings for UVC80/UVC50/UVC30 Room cameras. After logging in to the Windows system as an administrator, you can configure the camera parameters including exposure, graphic, white balance mode, people counting, and configuration hangup mode and camera pan direction.

For more information on how to configure camera parameters on the Yealink RoomConnect plug-in, please refer to [Yealink RoomConnect User Guide](#).

- [Setting the UVC80/UVC50/UVC30 as the Default Camera](#)
- [Controlling UVC80/UVC50/UVC30 Room Camera Position](#)
- [Creating the Preset Position for UVC30](#)
- [Resetting the Preset Position for UVC30](#)
- [Renaming the Preset Position for UVC30](#)
- [Setting UVC30 Camera to Preset Position](#)
- [Enabling/Disabling Auto-framing for UVC30](#)

Setting the UVC80/UVC50/UVC30 as the Default Camera

Procedure

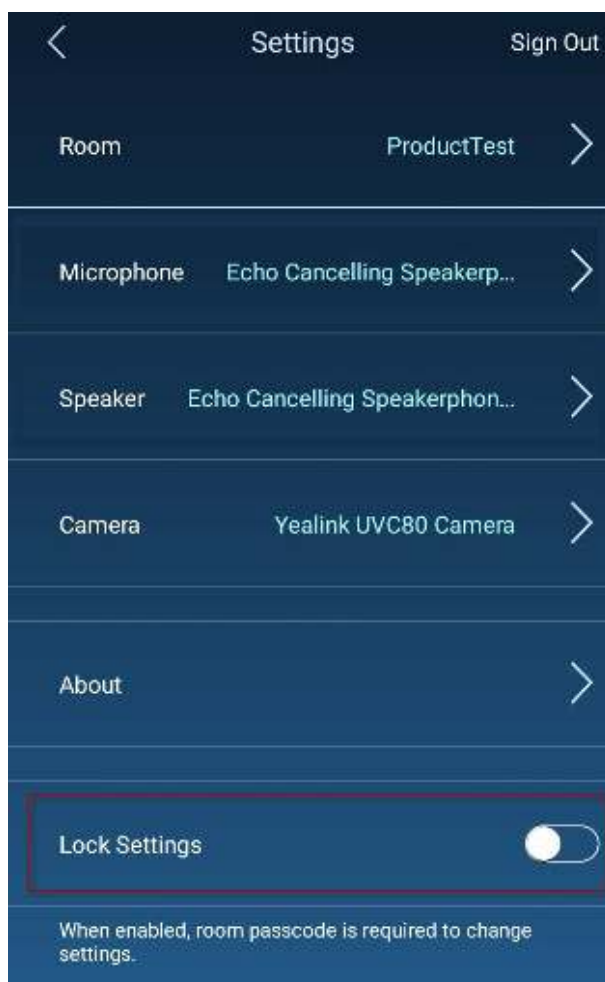

1. Tap  on the touch screen.
2. Disable **Lock Settings**.
You need to enter the room password to change the setting.



3. Tap the **Camera** field and then select **Yealink UVC80/UVC50/UVC30 Camera** as your default camera from the **SOURCE** field.

Controlling UVC80/UVC50/UVC30 Room Camera Position



Procedure

1. During a meeting, tap **Camera Control**.
2. Tap  /  to zoom camera out/in.
3. Tap the arrow keys to pan/tilt the camera.

Creating the Preset Position for UVC30

Presets specify the settings of both the angle and the focal length for the camera that can be used to quickly point a camera at a pre-defined location.



Procedure

1. During a meeting, tap **Camera Control**.
2. Tap  /  to zoom camera out/in.
3. Tap the arrow keys to pan/tilt the camera.
4. Long tap **Preset1/Preset2/Preset3** to create a new preset.

5. If the **Lock Settings** is enabled, enter the room passcode.
6. Long tap the corresponding preset and then select **Save position**.

Resetting the Preset Position for UVC30

Procedure

1. During a meeting, tap **Camera Control**.
2. Tap   to zoom camera out/in.
3. Tap the arrow keys to pan/tilt the camera.
4. Long tap **Preset1/Preset2/Preset3** to reset the preset.
5. If the **Lock Settings** is enabled, enter the room passcode.
6. Long tap the corresponding preset and then select **Save position**.

Renaming the Preset Position for UVC30

Procedure

1. During a meeting, tap **Camera Control**.
2. Long tap **Preset1/Preset2/Preset3** to rename the preset.
3. If the **Lock Settings** is enabled, enter the room passcode.
4. Long tap the corresponding preset and then select **Rename**.
5. Enter the new name.
6. Tap **OK**.

Setting UVC30 Camera to Preset Position

Procedure

1. During a meeting, tap **Camera Control**.
2. Select **Preset1/Preset2/Preset3** to set the camera to the preset position.

Enabling/Disabling Auto-framing for UVC30

Auto-framing is mainly based on face detection, which provides real-time detection and position tracking on all faces in the conference room. All participants in the output screen are covered and the camera can be automatically adjusted according to the number of participants and the position changes.

About this task

When the auto-framing feature is enabled, you can not control the UVC30 camera position.

Procedure

1. During a meeting, tap **Camera Control**.
2. Enable/Disable **Auto-framing**.

Content Sharing

You can present the content while the device is idle or during a meeting.

- [Wired Content Sharing](#)
- [Sharing Content with WPP20 Wireless Presentation Pod](#)
- [Stopping Sharing Content](#)

Wired Content Sharing

After the MShare is connected to the PC, you can use MShare for wired content sharing.

Procedure

Normally, it will start presentation automatically. If you stop content sharing manually on the touch screen, do one of the following:

- From the idle screen, tap **Presentation** to start content sharing.
- During a meeting, tap **Share Content or Camera > Start sharing** to start content sharing with the participants.

Sharing Content with WPP20 Wireless Presentation Pod

You can use Yealink WPP20 wireless presentation pod for wireless content sharing. Before content sharing, you should pair the WPP20 with the MShare and then connect it to the computer.

- [Pairing the WPP20 with the MShare](#)
- [Sharing Content via WPP20](#)
- [Stopping Sharing Content via WPP20](#)

Pairing the WPP20 with the MShare

Procedure

1. Connect the WPP20 to the USB port of the MShare.
2. Wait for about 3 seconds, and the WPP20 LED indicator glows green.

The WPP20 is paired with the MShare successfully.

Sharing Content via WPP20

Before you begin

Make sure the WPP20 has been paired with the MShare.

Procedure

1. Connect the WPP20 wireless presentation pod to your computer.
2. If the WPP20 is first connected to the computer, you need to manually start the Yealink Wireless Presentation Pod software from **This PC** in Windows 10 or from **My Computer** in Windows 7 and then upgrade the WPP20.

- After starting the software, if it prompts that the firmware version is different from the host version, you need to upgrade the WPP20 according to the prompts.
- For the WPP20 running old versions, after starting the software, you need to manually upgrade the firmware on the software at the path  -> **Version Update**.

After the upgrade is successful, the WPP20 is ready for content sharing.

3. Do one of the following:

- On the WPP20, press the presentation button to share the full screen.
- On the WPP20, long press the presentation button for 3 seconds and then release this button. Select the file or the window you want to share and then click **Start Sharing**.
- On the Yealink Wireless Presentation Pod software, click **Contents Share** and choose the file you want to share, and then click **Start Sharing**.

The content you want to share is automatically projected to the display device.

 **Tip:** Go to [Yealink website](#) for the latest version of the firmware.

Related tasks

[Pairing the WPP20 with the MShare](#)

Stopping Sharing Content via WPP20

Procedure

Do one of the following:

- On your computer, remove the WPP20.
- On the WPP20, press the presentation button.
- On the Yealink Wireless Presentation Pod software, click **Stop Sharing**.

Stopping Sharing Content

Procedure

Do one of the following:

- Tap **Presentation > Stop Sharing** on the presentation screen to stop sharing content when the device is idle.
- During a meeting, tap **Share Content or Camera > Stop Current Sharing** to stop sharing content with the participants.

 **Note:** After stopping content sharing, you can start presenting again as you need.

Using Hybrid Mode

Yealink Solution for Zoom Rooms supports the hybrid mode that allows you to switch between SIP mode and Zoom Rooms mode to experience Zoom video conferences as well as SIP calls and conferences. In SIP mode, you can use basic call features, including placing/answering calls, initiating a conference, recording calls, and so on.

- [Enabling the Hybrid Mode](#)
- [Switching Between SIP Mode and Zoom Rooms Mode](#)

Enabling the Hybrid Mode

The CP960 uses the Zoom Rooms mode by default. You can enable the hybrid mode to use so that you can both the Zoom Rooms mode and SIP mode.

Procedure

1. Swipe down from the top of the screen to enter the device setting screen.
2. Tap **Settings > Advanced Settings (default password: admin)**.
3. Turn **Hybrid Mode** on.
It prompts that if you are sure to switch mode.
4. Tap **OK**.
This configuration will take effect after a reboot.

Switching Between SIP Mode and Zoom Rooms Mode

After the hybrid mode is enabled, you can switch between SIP mode and Zoom Rooms mode quickly on the phone when you are not in a call.

Procedure

1. Under the Zoom Rooms mode, tap the floating circle to switch to the SIP mode.
2. Under the SIP mode, tap the floating circle or tap the **Zoom Rooms** app icon to switch back to the Zoom Rooms mode.

Related tasks

[Enabling the Hybrid Mode](#)

Basic Settings on the Phone

- [Setting the Language](#)
- [Setting the Input Method](#)
- [Time and Date Display](#)
- [Changing the Screen Backlight Brightness and Time](#)
- [Changing the Screen Saver Type and Waiting Time](#)
- [Setting the Signal Port of Yealink Plugin](#)

Setting the Language

Procedure

1. Swipe down from the top of the screen to enter the device setting screen.
2. Tap **Settings > Basic Settings > Language & Input > Language**.
3. Select the desired language.
4. Save the change.

Setting the Input Method

Before using the on-screen keyboard to enter data, you can set the input method. The CP960 supports the English (US)-Android Keyboard (AOSP) input method and Google Pinyin input method.

Procedure

1. Swipe down from the top of the screen to enter the device setting screen.
2. Tap **Settings > Basic Settings > Language & Input**.
3. Tap the **Current Input** and then select a desired input.

Time and Date Display

You can set the time and date manually. The time and date formats are also variable.

- [Setting the Time and Date Manually](#)
- [Changing the Time and Date Format](#)

Setting the Time and Date Manually

If your phone cannot obtain the time and date automatically, you can set it manually.

Procedure

1. Swipe down from the top of the screen to enter the device setting screen.
2. Tap **Settings > Basic Settings > Time & Date > General**.
3. Tap the **Type** field and select **Manual Settings** from the pop-up dialog box.
4. Enter the specific date and time in the corresponding fields.
5. Save the change.

Changing the Time and Date Format

You can set the phone to display the time in 12-hour format or 24-hour format. You can also change the date format, including the options to display the day (D), month (M), and year (Y).

About this task

The built-in date formats are listed as below:

Date Format	Example(2019-05-29)
WWW MMM DD	Wed May 29
DD-MMM-YY	29-May-19
YYYY-MM-DD	2019-05-29
DD/MM/YYYY	29/05/2019
MM/DD/YY	05/29/19
DD MMM YYYY	29 May 2019
WWW DD MMM	Wed 29 May

Procedure

1. Swipe down from the top of the screen to enter the device setting screen.
2. Tap **Settings > Basic Settings > Time & Date > Time & Date Format**.
3. Select the desired date format from the **Date Format** field.
4. Select the desired time format from the **Time Format** field.
5. Save the change.

Changing the Screen Backlight Brightness and Time

You can change the backlight brightness of the LCD backlight when the phone is active (in use). The backlight brightness automatically changes after the phone has been idle for a specified time.

Procedure

1. Swipe down from the top of the screen to enter the device setting screen.
2. Tap **Settings > Basic Settings > Display > Language > Backlight**.
3. Slide the **Active Level** slider to change brightness of the LCD backlight.
4. Tap the **Backlight Time** field and select the desired time.
5. Save the change.

Changing the Screen Saver Type and Waiting Time

The screen saver automatically starts each time your phone is idle for a certain amount of time. You can stop the screen saver at any time by pressing any key or tapping the touch screen. When your phone is idle again for a preset waiting time, the screen saver starts again.

About this task

Active Level: The intensity of the phone screen when the phone is active.

Backlight Time: The delay time to change the brightness of the phone screen when the phone is inactive. Backlight time includes the following settings:

- **Always On:** Backlight is on permanently.
- **15s, 30s, 1min, 2min, 5min, 10min or 30min:** Backlight is changed when the phone is inactive after the designated time.

Procedure

1. Swipe down from the top of the screen to enter the device setting screen.
2. Tap **Settings > Basic Settings > Display > Screen Saver**.
3. Tap the **Screensaver Waiting Time** field and select the desired time from the pop-up menu.
4. Select the desired background.
5. Save the change.

Setting the Signal Port of Yealink Plugin

Before you begin

Make sure that the signal port of Yealink Plugin you set on the phone is the same as the Yealink Plugin on your MCore.

Procedure

1. Swipe down from the top of the screen to enter the device setting screen.
2. Tap **Settings > Advanced Settings (default password: admin) > Yealink Plug-in Setting > Signal Port**.
3. Save the change.

Using the CP Wireless Expansion Mic CPW90

The Yealink CPW90 is a CP Wireless Expansion Mic which works as an audio input device for CP960 phone. It features superior audio technology and supports 360-degree voice pickup range at a radius of up to 10 feet (3 meters) without any wiring troubles.

- [Registering the CPW90](#)
- [Unregistering the CPW90](#)
- [Viewing CPW90 Information](#)
- [Finding the CPW90](#)

Registering the CPW90

To use the CPW90 as the external audio input device, you need to register the CPW90 first.

Procedure

1. Put the CPW90 on a charging cradle, the CPW90 starts up automatically.
2. Connect the micro USB port on the charging cradle to the USB port on the CP960 using a 0.3m USB cable.
The CPW90 enters the registration mode automatically. And the mute LED indicator on the CPW90 fast flashes yellow.
3. Swipe down from the top of the screen to enter the device setting screen.
4. Tap **Settings > Basic Settings > MIC > +**.
5. Long press the mute key on the CPW90 for 5 seconds.
The CPW90 is registered with the CP960 conference phone automatically.

Unregistering the CPW90

When you no longer need the CPW90 as the external audio input device, you can unregister it.

Procedure

1. Swipe down from the top of the screen to enter the device setting screen.
2. Tap **Settings > Basic Settings > MIC**.
3. Select the desired microphone and then tap **Detail**.
4. Tap **Unbind** to deregister the CPW90.

Viewing CPW90 Information

When the CPW90 is registered with the IP phones, you can view CPW90 status on the phone.

Procedure

1. Swipe down from the top of the screen to enter the device setting screen.
2. Tap **Settings** > **Basic Settings** > **MIC**.
3. Tap **Detail** from the desired microphone block.

Finding the CPW90

You can find the CPW90 which has registered with the phone.

Procedure

1. Swipe down from the top of the screen to enter the device setting screen.
2. Tap **Settings** > **Basic Settings** > **MIC**.
3. Tap **Find** from the desired microphone block.

The mute key LED indicator on the registered CPW90 flashes red and green alternately.

Switching Between ZoomRooms Account And ZoomRoomsAdmin Account

- [ZoomRoomsAdmin Sign-in](#)
- [ZoomRooms Account Sign-in](#)

ZoomRoomsAdmin Sign-in

You can sign in as an administrator and manage the device with administrator privileges.



Procedure

1. Tap **Settings** on the touch screen.
2. If the **Lock Settings** is enabled, enter the room password.
3. Tap **Windows Settings**.
4. Select the **ZoomRoomsAdmin** account from the bottom-left corner and then enter the password (default: zoom123) to return to the desktop of the MCore.

ZoomRooms Account Sign-in

If you switch to the administrator account to perform any action on the system, you can switch back to the ZoomRooms account.

Procedure

1. Click the  button, and then go to  > **Sign out** .
2. Select the **ZoomRooms** account from the bottom-left corner and then enter the password (default: zoom123) to enter the Zoom Rooms app.

Logging into Yealink Management Cloud Service/Yealink Device Management Platform

The Yealink RoomConnect plugin running under Windows automatically detect all devices in the Zoomm Rooms system. After logging to the Yealink Management Cloud Service or Yealink Device Management Platform via Yealink RoomConnect, you can manage all devices in the Zoom Rooms system, including the centralized upgrade, as well as diagnosis and alarm.

Procedure

1. Sign in your system as an administrator.
2. Run the **Yealink RoomConnect** plugin.
3. Tap  on the home page.
4. Select a desired platform to connect.
5. Depend on your choice:
 - If you select **Yealink Management Cloud Service**, enter the enterprise ID.
The enterprise ID can be obtained from the **Account Settings** on your Yealink Management Cloud Service.
 - If you select **Yealink Device Management Platform**, enter the server address.
6. Enter your meeting room.
7. Select the desired device model.
8. Tap **Confirm**.
The system will connect to the Yealink Management Cloud Service/Yealink Device Management Platform.

Related tasks

[ZoomRoomsAdmin Sign-in](#)

Troubleshooting

This section describes solutions to common issues that may occur while using the Yealink CP960-UVC Zoom Rooms kit. Upon encountering a case not listed in this section, contact your Yealink reseller for further support.

- [Upgrading System Software](#)
- [Upgrading the CP960](#)
- [Firmware for Each Device](#)
- [Checking Whether the Phone Can Access to the External Network](#)
- [General Issues](#)

Upgrading System Software

Windows Update is a service provided by Microsoft which provides security updates and functionality updates to Windows operating systems and its installed components. ZoomRooms account is the default account from which the Zoom Rooms app runs, so you need to switch to the ZoomRoomsAdmin account which has access to return to the desktop of the MCore to manage the devices (including the Windows, the UVC80/UVC50/UVC30 and the MShare). After switching the user account to ZoomRoomsAdmin, you can enable Windows Update service to update the devices.

You can also upgrade the devices on the Yealink RoomConnect plug-in under Windows or on the Yealink Management Cloud Service/Yealink Device Management Platform.

For more information on how to upgrade the devices on Yealink RoomConnect plug-in, please refer to [Yealink RoomConnect Userguide](#).

For more information on how to upgrade the devices on Yealink Management Cloud Service/Yealink Device Management Platform, please refer to [Yealink Management Cloud Service for Enterprise Administrator Guide](#)/[Yealink Device Management Platform Administrator Guide](#).

- [Enabling Windows Update Service](#)
- [Update the Devices](#)

Enabling Windows Update Service

Before you begin

Sign in as an administrator([ZoomRoomsAdmin Sign-in](#)).

Procedure

1. Open a command prompt window on your MCore.
2. Type **services.msc**, and press **Enter**.
3. Find **Windows Update** service, and double-tap to open **Properties**.
4. Enable **Windows Update** service from the **Startup type** field.
5. Click **OK**.

Update the Devices

The devices can be upgraded manually or can be automatically upgraded if you enable automatical Windows Update.



- [Enabling Automatically Windows Update](#)
- [Manually Windows Update](#)

Enabling Automatically Windows Update

Before you begin

Sign in as an administrator ([ZoomRoomsAdmin Sign-in](#)).

Procedure

1. Click the  button, and then go to  > **Upgrade & Security** > **Windows Update**, and select **Advanced options**.
2. Enable **Automatically download updates, even over metered data connections(charge may apply)**.

Manually Windows Update

Before you begin

Sign in as an administrator([ZoomRoomsAdmin Sign-in](#)).

Procedure

Do one of the following:

- Press the **Windows key + X** or right-click the  button to open the **Power User Menu** and then select **Device Manager**.

Right click the desired device and then select **Update driver**.

Select the desired way to update.

- Click the  button, and then go to  > **Upgrade & Security** > **Windows Update**, and select **Check for updates**.

Select the plugin or UVC80/UVC50/UVC30 camera and then complete the installation.

Upgrading the CP960

About this task

There are three ways to update the firmware:

- Update the firmware manually via web user interface
- Batch update a group of phones on the Yealink device management platform or Yealink Management Cloud Service
- Update the firmware manually Yealink RoomConnect plug-in



Note: For more information on how to update a batch of phones on the Yealink device management platform or Yealink Device Management Cloud Service, refer to [Yealink device management platform Administrator Guide](#) or [Yealink Management Cloud Service for Enterprise Administrator Guide](#).

For more information on how to upgrade the CP960 on Yealink RoomConnect plug-in, please refer to [Yealink RoomConnect Userguide](#).

- [Accessing the Web User Interface](#)
- [Update the Firmware Manually via Web User Interface](#)

Accessing the Web User Interface

Procedure

1. Swipe down from the top of the screen to enter the device setting screen.
2. Tap **Status** to obtain the IP address of the phone.
3. Open a web browser on your computer, enter the IP address into the address bar (For example., "http://192.168.0.10" or "192.168.0.10").
4. Enter the user name (default: admin) and password (default: admin) in the login page and then click **Login**.

Update the Firmware Manually via Web User Interface

Procedure

1. Download the latest version of CP960 Zoom edition from the [Yealink Support Website](#).
2. On the web user interface(https://IP address of the CP960), navigate to **Settings > Upgrade > Upgrade**.
3. Upload the firmware.

After the update, the CP960 will reboot automatically.

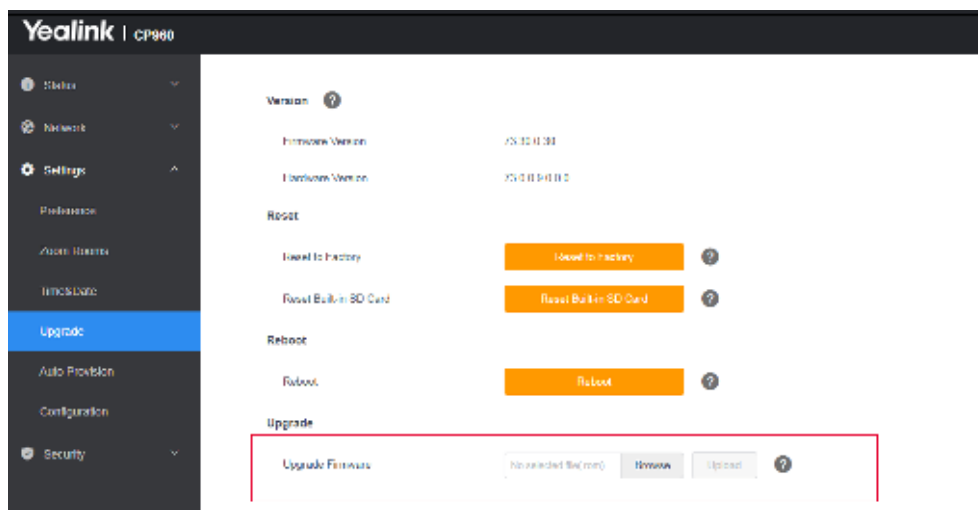

Firmware for Each Device

The firmware of the CP960, MShare, Yealink Plugin for Zoom Rooms plug-in and the Yealink RoomConnect plug-in the ZVC series Zoom Rooms Kit must match each other.

The following table lists the associated and latest firmware name for each device:

Device Model	Firmware Name
CP960	73.30.0.36.rom
UVC80/UVC50	92.420.0.15.rom
UVC30	105.420.0.10.rom
MShare	94.420.0.5.rom
Yealink Plugin for Zoom Rooms	1.0.24.0
Yealink RoomConnect	2.0.14.0

Checking Whether the Phone Can Access to the External Network

If it prompts that your phone is failed to pair, make sure that this tablet is connected to the internet. After you enter the pairing code on the phone, you need to check whether the phone can access the external network.

Procedure

1. On the web user interface, click **Network > Diagnosis**.
2. Select **Ping** from the drop-down menu of the **Command** field.

3. Enter **Zoom.us** in the **IP address** field.
4. Click **Start**.

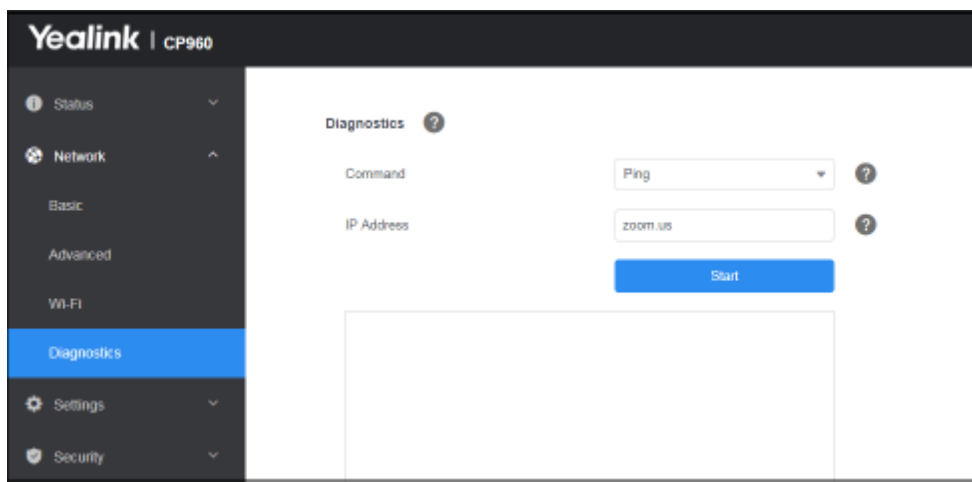

General Issues

- *Any Anti-virus Software Needed to Be Installed on the MCore?*
- *The display does not display the shared content*

Any Anti-virus Software Needed to Be Installed on the MCore?

Microsoft itself has Windows Defender, a legitimate antivirus protection plan already built into Windows 10. But not all antivirus software is the same, and you can choose antivirus software based on its ability to defend against threats.

The display does not display the shared content

- Make sure you have signed in the ZoomRooms account
- Make sure the Yealink UVC80/UVC50/UVC30 Camera is set as the default camera

Related tasks

[Signing Into Your Zoom Rooms Account](#)

[Setting the UVC80/UVC50/UVC30 as the Default Camera](#)